

A survey on multi-layer IP and optical Software-Defined Networks

Mirosław Kantor*, Edyta Biernacka, Piotr Boryło, Jerzy Domżał, Piotr Jurkiewicz, Miłosz Stypiński, Robert Wójcik

Department of Telecommunications, AGH University of Science and Technology, Kraków, Poland

Abstract

As Software-Defined Networks become more and more popular, they start to appear in various architectures. The most common utilization of SDN is to control the network in the electric layers, including OSI/ISO layers 2 and above. However, SDN can be used much further. Professionals and scientists noticed that combining management and control of many layers at the same time can provide benefits. At one point, SDN started to be envisioned for multi-layer networks.

In this survey we present, compare and contrast solutions that utilize SDN in multi-layer network architectures. The main objective is to analyze evolving multi-layer network architectures and show how these solutions coupled with SDN contribute to make future networks simple, flexible and cost-effective.

Keywords: SDN, Software-Defined Networking, multi-layer, optical networks

1. Introduction

Distributed approach to network management has been popular due to advantages it provides, such as no single point of failure and faster operation enabled by local decision making. For many years, such an approach dominated, even though it also created lots of difficulties. Vendors produced dedicated hardware in which they implemented their solutions and mechanisms. End users were limited only to the possibilities created by the manufacturers.

The situation changed when the concept of Software-Defined Networking (SDN) appeared. The main idea behind SDN is to provide a higher level of network management with programmable central device which controls all forwarding nodes. SDN is characterized in [1] by four principles:

- separation of control and data planes,
- logically centralized control,
- open interfaces,
- programmability.

Although SDN seems to have appeared suddenly, it is a part of a long history of efforts to make networks easily programmable. In [2] the authors follow the intellectual history of programmable networks, including active networks, early efforts to separate the control and data plane, and more recent works on OpenFlow and network operating systems. The idea of programmable networks were in

minds of many, however, *the work on OpenFlow and network operating systems struck the right balance between vision and pragmatism* [2].

The term SDN is very common in today's discussion about future telecommunication networks. Due to its potential, SDN is perceived as the one technology to enable and operate next-generation networks. SDN is likely to become the cornerstone upon which new architectures are built. It is envisioned for all types concepts, such as: 5G [3], mobile ad-hoc networks [4], Multi-Protocol Label Switching (MPLS) [5], Internet of Things (IoT) [6] [7] [8], vehicular ad-hoc networks [9] [10], smart cities [11] [12], and so on. It is clear that the facilitation of the network management process drives people towards a new paradigm.

The architecture of SDN is presented in Figure 1. It consists of three separate planes:

Application Plane Application plane is formed by programs that communicate requirements and network desired behavior to the SDN controller. These applications can build an abstracted view of the network by collecting information from the controller for decision making. These applications include: network analytics, network management, security and other business-related purposes.

Control Plane This plane is realized by the SDN controller. The controller is a logical entity that receives instructions from the Application Plane and controls the devices in the network to obtain given results. The controller also extracts information about the network from the devices and communicates back to the Applications Plane with an abstract view of the network and current traffic statistics.

*Corresponding author

Email address: `kantor@kt.agh.edu.pl` (Mirosław Kantor)

Data Plane This plane forwards all the data within the network. It comprises SDN switches which consult the controller with every decision, a normal router takes independently. Particularly, when a new flow arrives, a switch asks the controller for the action to be performed on the flow, and then stores this information inside its flow table for further packets of the flow.

The communication between planes is often referred to as northbound and southbound interfaces (or APIs). A Northbound interface is defined as the connection between the controller and applications, whereas the Southbound interface is the connection between the controller and the physical networking hardware.

The most common utilization of SDN is to control the network in the electric layers, including OSI/ISO layers 2 and above. However, SDN can be used much further. Professionals and scientists noticed that combining management and control of many layers at the same time can provide benefits. At one point, SDN started to be envisioned for multi-layer networks.

Multi-layer SDN unifies the control plane for the packet and transport layers and simplifies, orchestrates and automates provisioning operations in a multi-vendor, multi-layer environment. With cross-layer optimization, networks operations are simplified and the network resources are optimally utilized. Rather than continuing with present mode of operation (PMO) architectures, network operators can use SDN to extract more capabilities out of the evolving transport layer, and leverage its increasingly dynamic and agile capabilities. Thereby, the multi-layer networks become more efficient and flows can stay at the layer where it is optimal for cost and performance.

The main objective of this paper is to survey the literature on multi-layer SDN focusing on optical and electrical layers. The goal is to provide a deep and comprehensive understanding of this paradigm, its related technologies, its domains of application, as well as major issues that need to be solved towards sustaining its success.

1.1. Survey organization

The survey is organized according to the selected areas and topics which cover all important aspects of multi-layer SDN area. The structure of the survey is presented in Figure 2. Section 2 is dedicated to unveiling multi-layer SDN concepts, components, and architecture. It starts with a concise summary on SDN and optical networks, followed by an overview of an architecture framework for the control and management of multi-layer networks, along with multi-layer network architecture. The problems and solutions related to multi-layer resource allocation are presented in Section 3. SDN-based multi-layer monitoring, dynamic QoS-aware path and flow provisioning are described in Section 4. Section 5 is the survey of the research works on multi-layer SDN protection and restoration describing proposed resilient mechanisms against link

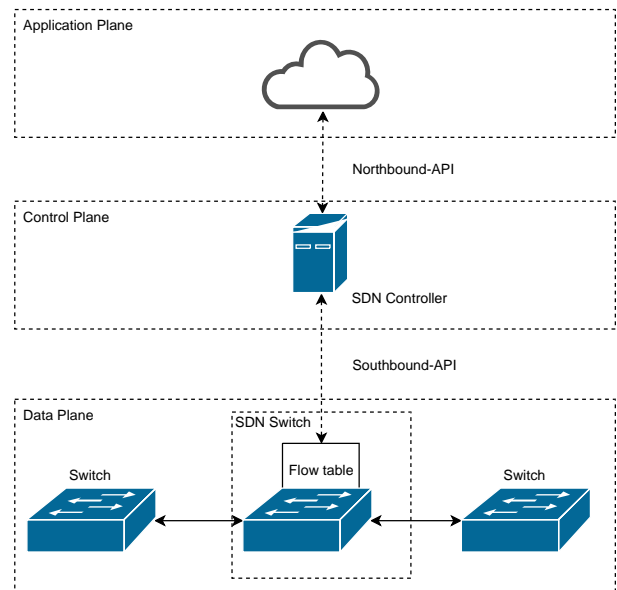

Figure 1: The architecture of SDN.

failures. SDN-based multi-layer controllers, orchestrators, emulators and testbeds are the topic of the Section 6. Section 7 describes the research on inter/intra-DC SDN. The topics not covered in the previous parts but relevant to the multi-layer SDN topic are covered in Section 8. These topics include access control, security, and multi-domain multi-layer networks. Finally, we outline open challenges and future research directions in Section 9. The paper ends with conclusions in Section 10.

—	Section 1: Introduction
	1.1 Survey organization
—	Section 2: Multi-layer SDN architecture framework
	2.1 Software Defined Networking
	2.2 General multi-layer SDN networking concept
—	Section 3: Multi-layer resource allocation in SDN
	3.1 Multi-layer dynamic resource allocation algorithms
	3.2 Green networking
—	Section 4: Dynamic QoS-aware path and flow provisioning
	4.1 Policy-based path computation
	4.2 Path computation in pseudowire multi-layer networks
	4.3 QoS-aware multi-path TCP for Software Defined Optical Networks
	4.4 QoS-aware Network Operating System for SDN with Generalized OpenFlow
—	Section 5: Multi-layer protection and restoration
	5.1 Resilience in case of link failures
	5.2 Resilience in case of node failures
	5.3 Other solutions
—	Section 6: Multi-layer SDN controllers, orchestrators, emulators and testbeds
	6.1 Controllers
	6.2 Orchestrators
	6.3 Emulators
	6.4 Testbeds
—	Section 7: Inter/intra-DC SDN
	7.1 Carrier perspective
	7.2 Mobile network operator perspective
	7.3 Service provider perspective
—	Section 8: Remaining relevant topics
	8.1 Multi-layer SDN monitoring
	8.2 Access control and security
	8.3 Multi-domain multi-layer networks
—	Section 9: Open challenges and future research directions
	9.1 Comparison of multi-layer SDN solutions
	9.2 Future research directions

Figure 2: Survey organization.

2. Multi-layer SDN architecture framework

The section provides background on SDN followed by a general concept of multi-layer SDN networking.

2.1. Software Defined Networking

The main paradigm of SDN is to separate control and data planes. The control plane is supervised by a logically centralized entity called an SDN controller while the data plane is composed of simplified forwarding devices, called SDN switches. Such an approach enables the deployment of globally scoped routing policies which are in contrast to an inefficient hop-by-hop approach. SDN assumes that the control plane and the data plane are separated to simplify the management of traffic in the network. At the control plane, usually the central controller decides to which interface packets should be sent at the data plane. This concept may be especially useful in multi-layer networks, for example to improve the efficiency of routing and wavelength assignment.

The architecture of SDN requires a communication channel between the planes. The OpenFlow Protocol (OFP) is designed for this purpose. Through the OFP the SDN controller sends, among the others, entries to be placed in switches' flow tables in order to implement globally scoped routing policies. Thanks to centralized nature of the SDN, the policies may easily be managed by a network administrator or automatically programmed by external applications integrated with the controller. Programmability, combined with controller's global knowledge about the network state, together with an abstraction of network layer exposed to the external applications, becomes the main advantage of the SDN concept which follows the network *softwareization* process. Despite opening attractive perspectives for network operators, SDN also raises numerous scientific and engineering concerns. The most important issues are related to scalability of its architecture based on a separate and logically centralized control plane.

In paper [13] a survey on quality of service aspects related to Software Defined Networks is presented. The present the potential Quality of Service (QoS) and Quality of Experience (QoE) benefits of SDN-based solutions. The following areas have been analyzed: Multimedia flows routing mechanisms, inter-domain routing mechanisms, resource reservation mechanisms, queue management and scheduling mechanisms, QoE-aware mechanisms, network monitoring mechanisms, and other QoS-centric mechanisms such as virtualization-based QoS provisioning and QoS policy management. Moreover, different versions of the OFP have been reviewed based on their implementations in commonly-known, open-source, and community-driven controller projects.

An SDN switch stores entries provided by the controller in a flow table. Each entry is composed of various fields, such as priority, cookie, statistics, and a list of actions, e.g. sending a packet to a particular output port. However, the

key element of each entry is a *match* field which defines packet parameters, usually related to a packet header fields at different OSI/ISO layers, required to assign a packet to a flow. During packet forwarding, selected fields are matched to an entry with the highest priority in the table, and actions associated with the entry are performed. Since SDN switches do not operate in the control plane, if such a switch receives a packet that cannot be matched to any entry in its flow table, it can either drop this packet or start the flow establishment process comprising optimization mechanisms. Such an approach is called *reactive*. This scenario requires sending at least a header of the packet to the controller in an OFPT_PACKET_IN message. Then, the controller prepares an adequate flow entry and sends it back to the node. However, the switch is not able to handle packets of the new flow until it receives a response from the controller. In order to successfully deploy sophisticated optimization mechanisms and mitigate the mentioned performance issues, a *proactive* flow establishment process may be deployed. This mode denotes that flow entries are installed in SDN switches before the first packet of a new flow arrives. However, prediction regarding the expected network load is obligatory to perform optimization for upcoming time window and prepare entries to be inserted in the forwarding table of a switch.

2.2. General multi-layer SDN networking concept

Most of the natural and engineered systems consist of a set of units interacting together in complicated patterns that can encompass multiple types of relationships, change in time, and include other types of complications [15]. In such complex systems multiple subsystems and layers of connectivity can be present. Thus, it is very important to take such *multi-layer* features into account while trying not only to understand but also efficiently use the existing resources of these complex systems.

In the telecommunications context, the concept of multi-layer networking is generally an abstraction of providing network services with multiple networking layers (technologies) and multiple routing domains. The different network layers and their technologies can be classified into Layer 0 (e.g. fiber-switch capable), Layer 1 (e.g. lambda switching capable), Layer 1.5 (e.g. TDM SONET/SDH), Layer 2 (e.g. Ethernet), Layer 2.5 (e.g. packet switching capable using MPLS), and Layer 3 (e.g. packet switching capable using IP routing) [16]. Routing domains are also commonly referred to as network domains, routing areas, or levels [17].

In the context of multi-layer networking two approaches are considered: vertical layering or horizontal layering [17].

In vertical layering, multiple technology layers connect within a single domain. For example, the routing layer, may employ a selected technology (commonly the Internet Protocol (IP)) to use another (underlying) layer (the optical layer) to provide services to higher layers. On the other hand, in horizontal layering, technology layers work

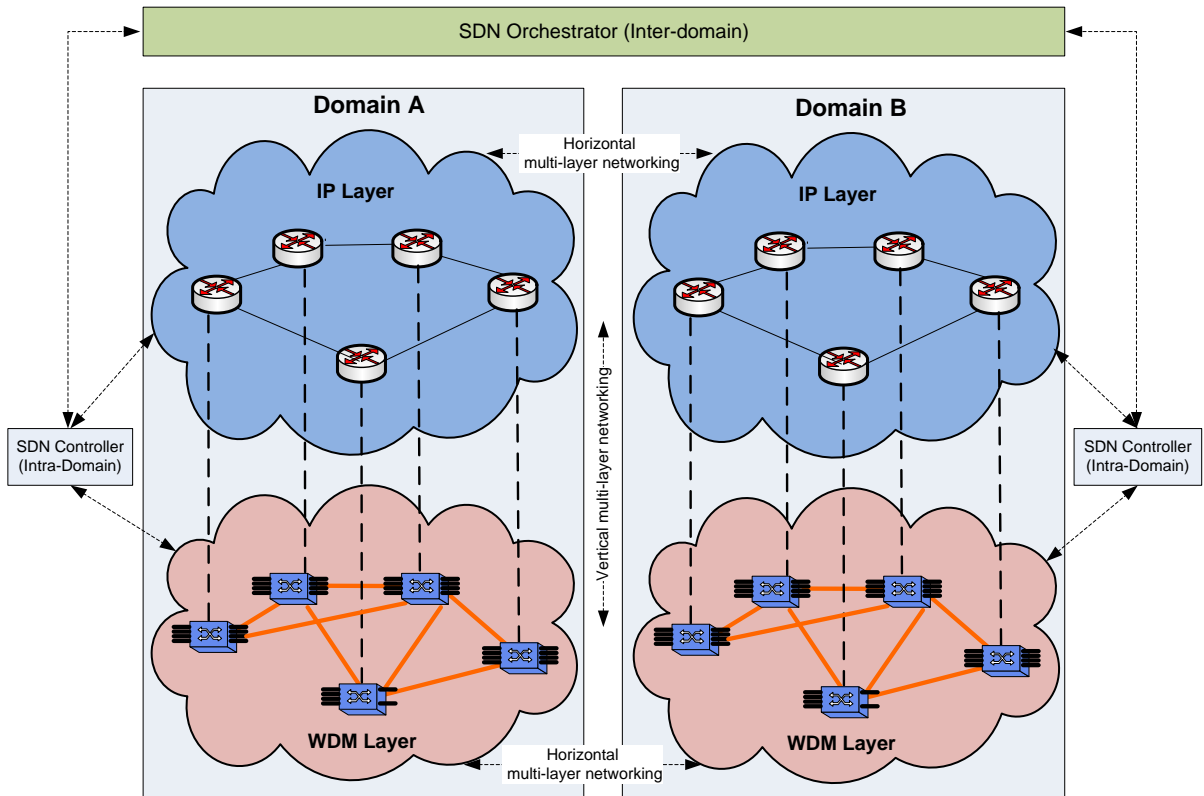

Figure 3: Illustration of SDN orchestration of multi-layer networking proposed in [14].

across distinct domains to provide a required service by setting up a service path across multiple routing domains.

Horizontal multi-layer networking can be viewed as a generalization of vertical multi-layer networking in that the horizontal networking may involve the same or different (or even multiple) layers in the distinct domains.

SDN-based multi-layer networking generally refers to network architecture encompassing multiple network layers in combination with SDN applied for network control [17][18][19][20]. There are many kinds of scenarios where SDN approach can be applied, such IP networks, optical metro networks, optical access networks, data center networks, wireless communication network, IoT, and so on. Due to a wide landscape with variety of SDN-aware network scenarios in the survey we decided to focus on a data plane with IP and optical layers as transport networks. The general concept of such an approach is illustrated in Figure 3. SDN controller is a brain of any SDN system. In case of multi-layer or multi-domain networks networks, multiple controllers are often necessary. This is due to lack of interoperability between multiple vendor devices or specificity of different layers. These controllers need to be coordinated which is the task of SDN orchestrator.

The primary function of the orchestrator is translating the application level service requirements into appropriate configuration requests for both the underlying IP and op-

tical network layers. The orchestrator is also in charge of end-to-end connectivity provisioning, using an abstracted view of the network and also covers inter-layer aspects. The provisioning capability enables the creation, deletion and update of connections in the network. The orchestrator also targets the re-optimization of the allocated resources by taking into account the requirements from all involved layers. It is important to note that basically two types of approaches coexist in the context of implementation SDN controllers for multi-layer networks. One of them assumes that different controllers are responsible for different layers of network infrastructure and communicate with each other in either controller-to-controller or hierarchical manner. Second approach assumes that one controller directly communicates with devices operating in both optical and electrical layers. Regarding the controllers and orchestrators more details are provided in Section 6.

We would like to highlight that the vertical multi-layer SDN network approach, encompassing IP and optical layers within a single domain, with SDN as the system orchestrator is the main point of interest in the survey. The motivation for choosing optical layer in addition to IP layer is the fact that optical networks are deployed more commonly in the network infrastructure. Despite their advantages, there are many drawbacks which need to be mitigated in order to utilize all the opportunities which opti-

cal network provide. Optical network are more sensitive to congestions and less flexible regarding routing capabilities. Furthermore there is a need for integration between current and newly deployed optical networks which lack resilience and transparency [21]. Thus, SDN application in such a multi-layer environment encompassing both IP and optical networks leverages the electrical and optical resources and alleviates potential issues.

The application of SDN to multi-layer network environment brings a plenty of advantages to the management of multi-layer, e.g. IP/optical, networks. First of all, SDN provides a centralized, coherent and unified view of the multi-layer network environment. The global visibility provided by the multi-layer SDN control technology enables performing integrated control of the optical layer and the IP layer attempting to fulfill the QoS requirements of incoming traffic demands with the most efficient combination of optical and electronic resources.

The ability to selectively control which traffic is transmitted through which network paths can also help service providers and enterprises to deliver services dynamically with maximum efficiency. In multi-layer networks, it is necessary to define mechanisms that efficiently use the resources available at both layers in a coordinated manner. With multi-layer SDN centralized control, a network can transport services over the most efficient technology, to use each layer's resources to the maximum extent possible by performing e.g. packet routing control on the IP layer and optical-wavelength routing control on the optical layer, if that were the most efficient way. By applying such a holistic approach a comprehensive route computation can be executed enabling the efficient usage of network resources [22].

Furthermore, multi-layer SDN networks can also help to coordinate the reaction of the involved layers to emerging failures. Instead of waiting a predetermined amount of time (i.e. hold-down time), the SDN controller will simply address the failure immediately at the most appropriate layer, which will result in shorter downtimes.

Moreover, coupling SDN concept with network virtualization is promising in terms of heterogeneous networks. Virtualization gives an opportunity to present network devices as a set of virtualized capabilities. Simplified and more generalized representation enables SDN applications to cooperate with various networking technologies [23].

Finally, SDN-based applications could be developed for providing dynamic traffic engineering mechanisms aimed at congestion management and network optimization. Such mechanisms, utilizing a centralized and global view of the multi-layer network provided by SDN, would recognize congestion in the network and working with the SDN controller would add bandwidth at a lower layer, to alleviate the congestion, or ask an upper layer to reroute traffic around the congestion, thus, efficiently use the available network resources at all layers.

3. Multi-layer resource allocation in SDN

Resource allocation problem in SDN is one of the elements which still should be considered as a key research area for SDN. There are many articles on that topic. They are mostly summarized in [34], which is the survey of possible resource allocation methods proposed for SDN in 2014-2017. The authors put their attention mostly to issues related to proper distribution of resources according to incoming requests for flows. The resource allocation aspects for SDN-based 5G cellular networks are presented in [35]. In [36], SDN-based resource allocation solutions are presented for heterogeneous LTE and WLAN multi-radio networks. A survey on SDN with multiple controllers is presented in [37]. In the mentioned article the aspects of benefits and disadvantages of implementation of many controllers are analyzed. While many controllers improve reliability and some operations, they also increase complexity and may cause some management problems.

In this paper, we analyze resource allocation aspects for SDN, but taking into consideration also multi-layer requirements and limitations.

Multi-layer resource allocation algorithms should jointly consider IP and optical resources. Multiple papers addressed this problem from wide variety of perspectives. This section presents resource allocation mechanisms found in the literature. All of the approaches are categorized with respect to the proposed approach. Moreover, we dedicated separate subsection to green-aware resource approaches. Taxonomy proposed in this Section is presented in the Figure 4.

3.1. Multi-layer dynamic resource allocation algorithms

The ACINO project (i.e. [24], [25], [26], [27]) delivers a multi-layer resource allocation and optimization framework implemented in Net2Plan. The preliminary description of this framework can be found in [26]. To provide optimal paths (connectivities) for service requests, the framework explores single layer elements (modules) without involving changes in infrastructures and hybrid layer elements. Firstly, the resources in the IP layer are considered to serve a request (IP Provisioning (IPP)). When resources are sufficient to serve a request, then resources are allocated and a connection is established. Otherwise re-optimization of existing connections in the IP

layer is triggered IP Optimization (IPOPT). Connections are rerouted with hitless manner (make-before-break) to make room for the request. This operation can minimize the number of utilized links as well as other cost functions. It is worth to mention that re-arranging can also run with adding new links. Apart from re-optimization, if the requested service is not feasible, then the possibility of adding new links Optical Layer Provisioning (OPP) is considered. To extend the set of links in IP, setting new lightpaths is considered in the optical layer. If possible, a new lightpath can be established, optical resources of such a lightpath are reserved and then a new link appears in IP. After adding potential links (if such links exist), resources required for the service are searched again. When the path is found then potential lightpaths corresponding to links which are chosen for path service, are established. Additionally, re-arranging connections can be involved with Optical Layer Provisioning (Multi-Layer Optimization (MLOPT) [27]). In this case, traffic is rerouted through paths of existing and potential links. Figure 5 shows framework elements [25]. Presented algorithm can be implemented as a part of the network orchestrator.

Each element of the ACINO framework such as IP optimization, multi-layer optimization, IP provisioning and optical provisioning implements the auxiliary graph model. Constructed graph consists of existing lightpaths edges and potential lightpaths. Existing lightpaths are lightpaths previously established, which can offer enough capacity for a demand, whereas potential edges are possible newly set-up lightpaths [24], [26].

To deal with the multi-layer mapping problem in dynamic network scenario, an auxiliary graph model also is adopted in [28]. The auxiliary graph is constructed based on: available transponders connecting optical and electrical nodes (transceiver edges), existing links in the electrical (IP) layer with enough capacity (existing lightpath edges) and potential lightpaths (potential lightpath edges). A potential edge appears in the graph if it is possible to establish a new lightpath. Based on assigning weights to edges and implemented path selection policies, a path can be found in sets containing only existing or existing and potential edges e.i. the shortest path with enough capacity is selected based on the physical length. Firstly, node-mapping runs and the average bandwidth requirement of

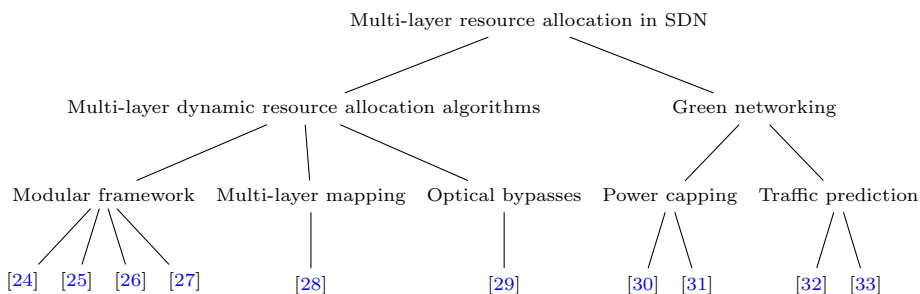

Figure 4: Structure of the Section 3.

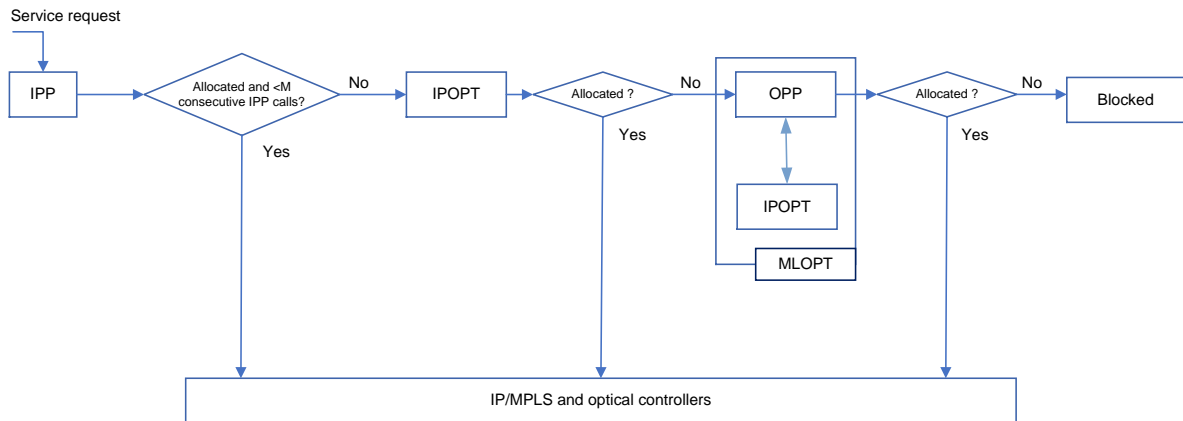

Figure 5: The ACINO framework [25].

Table 1: Comparison of dynamic resource allocation algorithms.

	ACINO (Savi et. al. [24] [25], Rozic et. al.[26]), Skoldstro et al. [27]	Zhang et. al. [28]	Biernacka et. al. [29]
Approach	modular framework	multi-layer mapping	optical bypassing
Auxiliary graph-based	Yes	Yes	–
Re-optimization connections	Yes	No	No
Traffic model	Poisson	Poisson	Poisson
Different traffic class	Yes	No	No
Routing in IP	multi-path	multi-path	single-path or bypasses
Optical technology	DWDM, EoN	WDM	EoN

virtual links is considered for the graph. After successful node-mapping, the graph is constructed based on the current network state and the requested bandwidth to map links. Through numerical simulations using the Poisson traffic model, the auxiliary graph was verified for the embedding problem in IP over Wavelength Division Multiplexing (WDM) network.

Another approach assumes resources for one path at IP and when congestions occur, additional resources are assigned for demands. In [29] the bypassing method is proposed to avoid congested links in IP over Elastic Optical Network (EoN). The mechanism creates new bypassing lightpaths in the EoN layer according to link utilization and available resources in the network. For requests, which cannot be served in the IP layer, bypasses are created. If resources along a given path in the IP layer (e.g. OSPF) are not sufficient for a request, the central controller attempts to find and establish an end-to-end lightpath to offload traffic associated with the request. At the IP layer such a bypass is seen as a one hop path. Additionally, using sliceable bandwidth variable transponders each sub-carrier can be used as an independent bypass terminated in a different node. Significant improvements are reported in the context of bandwidth blocking probability and resource usage in the IP layer. In experiments, requests are generated according to a Poisson process, with an exponential holding time.

The summary of presented dynamic resource allocation algorithms is provided in Table 1.

3.2. Green networking

Green networking concept has been widely considered from numerous perspectives and this fact is also reflected in the research area of multi-layer SDN networks. It is especially reasonable that the most fundamental properties of SDN can provide significant improvements in the energy-awareness context. More precisely, SDN controller is able to accumulate global knowledge not only about current network conditions but also energy-related parameters, like for example, current energy consumption of devices in different layers, availability of cheap or renewable energy, and many others. Based on that knowledge network wide energy-aware optimization may be performed comprising both optical and electrical layers. There is a lot of papers dealing with green networking in multi-layer SDN context. They can be classified as belonging to one of two main groups: first group of works is based on the power capping technology to limit server's energy consumption in data centers while the second group utilizes traffic prediction mechanisms to ensure energy efficiency respecting quality of service requirements. The overview of the selected papers assigned to both groups is provided below in the respective subsections.

3.2.1. Power capping techniques

First group of works is based on the power capping technology which is a well known approach to limit server's energy consumption in data centers. Power capping aims at managing peak power consumption using techniques such as dynamic voltage and frequency scaling. In more sophisticated cases power capping can be integrated with admission control mechanisms to postpone time-tolerant tasks or with virtualization layer to distribute computational demanding tasks among the servers in the energy-aware manner. Authors in [30] adopted power capping techniques to multi-layer SDN networks in order to effectively utilize *green* energy powering network nodes. The centralized nature of SDN control plane creates an opportunity to collect current data about energy cost and types of energy sources. A network is composed of nodes comprising two components, carrying data in electric and optical (WDM) layers respectively. Dynamic network operation is assumed with flows arriving on-demand without any knowledge about request holding time. Each data flow may occupy a fraction or a full wavelength's capacity. The SDN controller is further responsible for routing each dynamically arriving flow through the network. Once a request arrives, the SDN controller tries to handle it using an existing fully optical path (without energy-hungry O/E/O conversion in transit nodes). Only if such a path does not exist, the controller attempts to establish new all-optical lightpath between the source and destination nodes. If it is not possible, the controller tries to route the path through the transit node performing O/E/O conversions and switching in electric layer. The rationale of the proposed strategy is to limit the overall energy consumption comprising mainly operations performed in the electrical layer. The decision logic is presented in Figure 6.

The main contribution and the most novel aspect of [30] regards the fact that authors defined three power capping levels (PC0, PC1, and PC2). They reflect energy consumption limits applied to a node. PC0 level denotes unlimited energy consumption and preference of those nodes to perform energy demanding tasks (handling traffic in the electric layer). PC0 is assigned to nodes powered by green energy and the rationale is to fully utilize it. On the other hand, PC2 level blocks labeled network nodes from handling transit traffic (not originating nor destined to that particular node). PC2 level is assigned to network nodes powered from expensive brown energy what is expected to result in significant improvements. Finally, PC1 nodes are allowed to handle transit traffic in the electric layer (in contrast to PC2 nodes), but they are not preferred for this purpose (contrary to PC0 nodes). Authors investigated different strategies of power capping levels assignment in function of green energy availability. The amount of traffic switched at the electric layer is a measure of energy consumption and was considered in function of a power capping level assigned to the selected nodes.

Simulation-based approach has led to numerous valu-

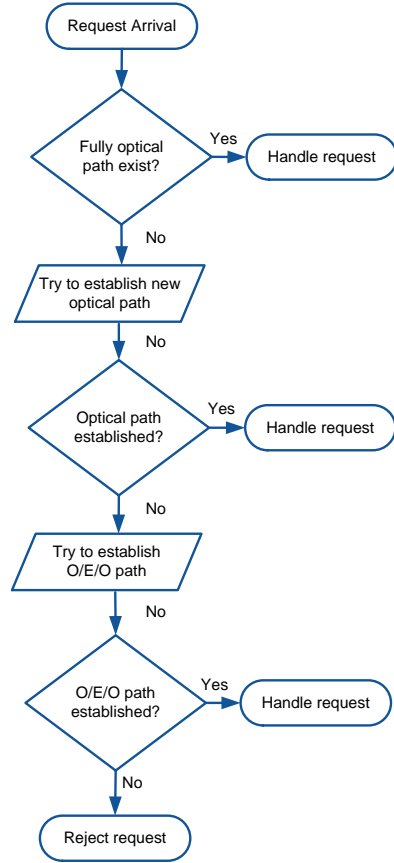

Figure 6: Multi-layer connection establishment process proposed in [30].

able conclusions. First of all, assigning PC0 level to preferred nodes results in tremendous shift in energy consumption from brown to green network nodes. However, it comes at the cost of increased Bandwidth Blocking Ratio (BBR) which diminishes operator's revenue and is caused by increased average lightpath length. One may expect that assigning PC2 level to nodes powered from brown energy may strengthen this effect. Surprisingly, conducted research proved and explained reasons why it actually limits the positive effect of energy consumption shift. However, assigning PC2 level to brown nodes reduces the overall BBR which improves the network performance. An important aspect of the research regards to the fact that authors investigated different combinations of nodes powered from green and brown energy and drew conclusions about desirable properties of nodes that should be labeled with particular power capping level.

The same authors further extended their work in [31] investigating the power capping approach under the assumption of variable number of green nodes in multi-layer SDN network interconnecting data centers. The number of carefully investigated green nodes was ranging from 1 to 13 which resulted in a comprehensive study. The efficiency

was measured in terms of the network’s carbon footprint reduction. Presented results proved that the proposed *InterDCgreen* strategy outperforms reference approaches when the average number (between 4 and 10) of network nodes is powered from green energy. The blocking probability is a second indicator which slightly grows as the proposed strategy is applied. However, authors also found some unfavorable simulation scenarios for which the network deterioration may be significant, the issue is especially troublesome for green nodes.

3.2.2. Traffic prediction mechanisms

The second approach to green multi-layer SDN networks utilizes traffic prediction mechanisms to ensure energy efficiency respecting quality of service requirements. WDM and EoN technologies were considered in [32] and [33] papers, respectively. The general aim of the former paper is to avoid energy-hungry optical layer resource over-provisioning, while the later reduces the number of light-path termination and establishment processes which further limits the number of energy-consuming network re-configurations.

Optical resource over-provisioning is the most popular way to ensure resilience and handle transient peak traffic loads. However, such a solution imposes additional costs related also to the energy consumption. Therefore, it is reasonable to limit abundant resources and improve energy efficiency. The solution proposed in [32] balances the load between optical transponders and electric ports. The main assumption is that dynamic traffic fluctuations should be switched in the electronic layer to mitigate the issue of fully utilized optical resources. Such an approach reduces the necessity for additional optical lightpaths, and as a result, also limits over-provisioning of optical transponders. Proposed solution takes advantage of SDN to assign optical layer equipment and employ bandwidth variable distance adaptive modulation and coding. SDN capabilities are also utilized to perform optimization in two time spans: mid-term and short-term. In a longer perspective, the number of optical transponders and the major network infrastructure changes are optimized under the constraint of throughput available in the electric layer. In a shorter time horizon, solution aims to handle traffic variations resulting from differences between the current network load and values assumed during long-term optimization process.

The aspect of cooperation between optical and electrical layers under control of SDN is the most novel, and simultaneously, an interesting part of [32]. Namely, traffic predictions are performed for the entire mid-term time horizon and optical lightpaths are optimized in an offline manner, and thus, remain unchanged during the whole time window. On the other hand, switching in electric layer is assumed to operate in a dynamic manner to handle traffic fluctuations occurring in the network (contrary to the prediction for the mid-term time horizon). The rationale is to handle the traffic using provisioned opti-

cal resources when those predicted resources ensure sufficient capacity. But when overall network load increases, electric switching is performed to fully utilize the existing lightpaths. Such an approach is possible thanks to the SDN capabilities and reduces over-provisioning of optical resources. It is because aggregation in electric layer is used as long as it is possible to handle traffic without powering on energy-hungry additional optical transponders. The Seasonal Auto-Regressive Integrated Moving Average (SARIMA) model is used to predict network load during prediction phase. Predicted demands are provided as an input to the energy-aware linear programming problem formulated and solved during the research. All of the analytical details are carefully explained in [32].

Network architecture in [32] is as follows. Each multi-layer network node comprises the IP router, the Electronic Switching Module (ESM), Optical Transponders (OT), MUX/DeMUX, and the Optical Cross Connects (OXC). Each router feeds both, mid-term and short-term traffic forecasts mechanisms with information about current and historical network load. Based on that input the SDN controller computes expected demands volumes. Mid-term traffic prediction triggers the process of solving an off-line optimization problem. As a result OT are switched on or off and optical switching and multiplexing commands are applied to MUX/DeMUX and OXC. Complimentary, an on-line problem solution is constantly being solved during network operations and as a result the SDN controller provides routing commands to ESM. Multi-layer energy-aware aspects are also considered in the SDN controller. Namely, the solution implements the energy consumption model of all network devices in function of on/off state and utilization level. The architecture of the solution is presented in Figure 7.

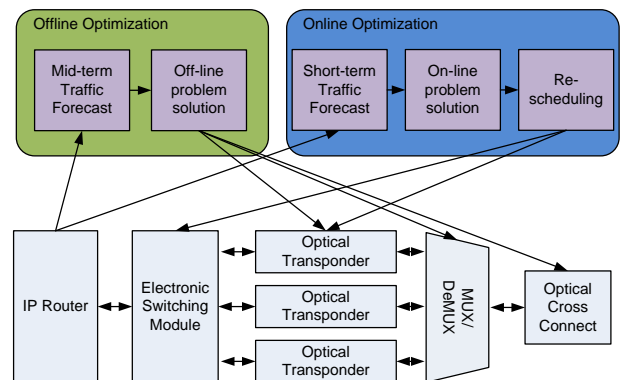

Figure 7: Architecture of the solution proposed in [32].

The proposed solution was compared with two reference scenarios. The first one assumes fixed optical transponders provisioned based on the peak hours load. The second one was deprived of traffic grooming capabilities performed in an on-demand fashion, and thus, is not able to dynamically balance the load between optical and elec-

tronic layers. One week and three hours periods are considered for mid-term and short-term perspectives, respectively. Presented results show that it is possible to meet QoS constraints when optical resources over-provisioning is limited based on stochastic traffic management. Significant (almost 50% in both cases) improvements in terms of energy efficiency and the number of active lightpaths in the network were presented while congestion requirements are satisfied.

The works mentioned above considered WDM-based optical networks. However, the emerging EoN technology is indicated as the one which will replace WDM. The main advantage of EoN regards the fact that it operates on the frequency slots which further compose optical channels of spectral width that may be adjusted to the actual traffic demand. It is achieved using Bandwidth Variable Optical Transponders (BV-OT) and even strengthened thanks to the Bandwidth Variable Optical Cross Connects (BV-OXC) deployed in the network. EoN advantages are especially valuable when considering networks connecting data centers, and authors in [33] considered such an example. As inter data center traffic is expected to increase, they found it reasonable to propose a solution utilizing advantages of SDNs to improve energy-efficiency of multi-layer EoNs connecting data-centers. Considered architecture comprises, mainly, IP Routers and BV-OXCs, both compatible with the OpenFlow protocol with extensions specific for multi-layer networks. Other components of the architecture are Erbium Doped Fiber Amplifier (EDFA)s, BV-OTs and data centers with servers. A very important assumption regards the fact that computing resources inside data centers and network elements are under the control of the same SDN controller. Global knowledge of the SDN controller about the network state enables handling incoming requests in an on-demand manner. Thanks to these benefits, the proposed solution may be easily implemented in any centrally controlled infrastructure.

The fundamental assumption taken in [33] regards the fact that the process of lightpath termination and reestablishment is highly energy-consuming. Therefore, the authors proposed a solution to detect (base on the prediction process) lightpaths that may be useful in the nearest future and protect them from termination and reestablishment after some time. As unnecessary, energy-hungry operations will be limited, overall energy consumption is

expected to decrease. Threefold contribution is reported by the authors. First of all, the energy consumption model is proposed which comprises not only energy requirements of network and server resources but also the cost of terminating and setting up lightpaths. Secondly, back propagation, neural networks and improved particle swarm optimization (IPSO) techniques were combined to predict future demands. Finally, the most important contribution regards the adjustable algorithm which decides if the termination of particular lightpath should be delayed due to the expected upcoming requests.

The proposed algorithm was evaluated in the environment composed of well known tools like Mininet and Floodlight controller combined with author’s original simulation building platform. Two different network topologies were investigated and five performance indicators were considered. Three of those indicators reflect the algorithm’s performance in terms of energy consumption and are denoted as: total power consumption of network and computing resources, number of newly established lightpaths, and power savings expressed in a relative metric. Two additional indicators (bandwidth blocking ratio and resource utilization rate) analyze the impact of the algorithm on network performance. Authors compared their solution with existing approaches and provided numerical results. It was shown that the proposed algorithm is able to provide significant improvements in terms of energy consumption as the number of lightpaths’ setup is decreased. Simultaneously, network performance indicators proofed that network was not significantly deteriorated.

Table 2 summarizes all of the presented approaches to green networking in multi-layer SDN networks. Each approach was briefly summarized while the energy model and the optical layer technology were mentioned. Table 2 also informs if an on-demand approach was considered or long-term optimization took place. The most important insight regards to the fact that each work either focuses on electrical or optical layer in terms of energy consumption. Thus, it will be valuable to propose SDN-based approach to energy consumption comprising both layers. Furthermore, in our opinion more attention should be put to consider possible improvements that SDNs can bring to the IPoEoN architecture in terms of energy consumption.

Table 2: Comparison of green networking approaches in SDN multi-layer networks.

	Rzasa et. al. [30]	Rzasa et. al. [31]	Khodakarami et. al. [32]	Xiong et. al. [33]
Approach	Power capping	Power capping under changing <i>green conditions</i>	Traffic prediction	Traffic prediction
Source of energy consumption	Switching in electrical layer	Switching in electrical layer	Active optical transponders	Lightpath establishment process
Optical technology	WDM	WDM	WDM	EoN
On-demand solution	Yes	Yes	Yes	Yes
Long-term optimization	No	No	Yes	No

4. Dynamic QoS-aware path and flow provisioning

The chapter starts with works considering path computation in multi-layer networks respecting policies imposed by different QoS requirements. Next, path computation aspects in pseudowire multi-layer networks are considered in this context. In the next two subsections, QoS-aware solutions are analyzed for Multipath Transmission Control Protocol (TCP) SDN optical networks and Network Operating Systems (NOS) with Generalized Open Flows, respectively.

4.1. Policy-based path computation

Some applications (e.g. synchronous data replications) require low latency and do not tolerate service disruptions. On the other hand, applications such as large scale off-line backups tolerate delay and service disruptions. As can be seen, requirements of applications can be different. Commonly, the optical layer treats applications in the same way without any differentiation. In this case, the bandwidth is not guaranteed. To treat applications according to their needs (e.g. maximum tolerance of delay, minimum tolerance of end-to-end path availability, required protection, dedicated optical channel, encryption, security), specific policies are implemented within the framework delivered by the ACINO project (e.i. [26], [25], [38]). Such policies verify different parameters (e.g. parameters of candidate paths) to meet application requirements. The latency-awareness policy checks the overall delay of candidate paths. Calculated delay can assume only the propagation time of links along the path or in addition processing delay in routers. In the availability policy, the overall availability or the failure probability of each optical link is calculated. The IP/MPLS protection tries to find two disjoint paths. The paths are disjoint in terms of IP links, intermediate routers, physical links. Such paths protect the applications against fiber cuts, IP router and IP port failures. In addition, disjoint paths satisfy all application requirements. The security policy (the optical class) assigns dedicated optical channels i.e. WDM channels, whereas the encryption policy provides the encryption traffic for an application.

Single application-aware policy or a combination of policies provides differentiation of traffic classes. These can be, for example, the silver class (latency-sensitive), the gold class (latency-sensitive, high-availability and protected class) presented in e.g. [26], [25], [38]. Consequently traffic flows of different applications are routed through the network in different ways according to application needs. For example latency-sensitive traffic is routed along a single-hop path, whereas the gold traffic class requires dedicated, disjoint, high-availability single-hop paths.

Using the Online Simulation Tool of Net2Plan, different application-aware policies of the ACINO project were evaluated in dynamic network scenarios. Service requests were generated according to a Poisson process. It was shown that application-aware strategies mistreated much less than the application-unaware one, whereas resources usage were similar for application-aware and the application-unaware policies.

In [39], the authors proposed a dynamic resource allocation strategy for packet optical services as well as a congestion control mechanism in packet optical networks. The optimal path for the end-to-end circuit is provided based on impairment and Network State-Aware Routing. Initially, the SDN controller allocates the minimum capacity required for a service and then monitors the utilization of circuits in a network. The controller decides whether to add or remove a transport circuit from a service by comparing the measured bandwidth of the packet flow with user-defined upper and lower thresholds circuit. For example, if the bandwidth exceeds the upper threshold, the SDN controller decides to create additional channels to provide sufficient capacity. Also, the controller monitors the bandwidth of different client services of the Optical Virtual Private Network (VPN). When bandwidth of a particular client service is higher than the maximum optical VPN transport capacity, then this service is rerouted over less congested Optical VPN.

In [40], the authors present the Automatic Hidden Bypasses (AHB) mechanism to minimize congestions occurring in the IP layer. When the utilization of any link exceeds a certain threshold, new lightpaths can be created. The mechanism assumes using as much optical resources

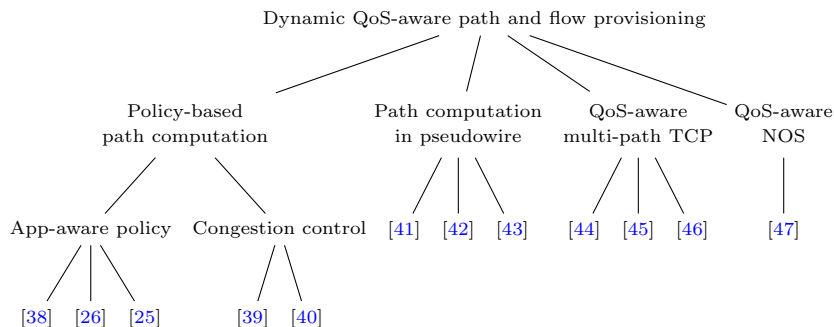

Figure 8: Structure of the Section 4.

as necessary in each situation. An optical bypass can be established on demand, and it is transparent to the IP layer. Such a mechanism does not require routing table updates. Only the bypass ingress node is informed that certain transmissions should be forwarded into the bypass rather than to the interface indicated by the routing table.

4.2. Path computation in pseudowire multi-layer networks

In [41], the problem of path computation in pseudowire multi-layer networks [42] is analyzed. The authors point out that in current networks different layers are managed through separate control planes. The path computation problem can be solved more efficiently when both layers cooperate. Designing one control plane would allow the network resources to be optimized and, as a consequence, the operational management costs to be reduced. There are, however, several problems with such an approach. One key difficulty is protocol heterogeneity and multi-layer context dealing with encapsulation, conversion and decapsulation of protocols. In pseudowire networks, the control plane is unified to provide functions in heterogeneous networks to allow multi-layer services. It defines encapsulation and decapsulation of protocols, i.e. one protocol is encapsulated into another. This allows the emulation of various services (e.g. Frame Relay, SDH, Ethernet, etc.) over packet-switched IP networks.

The authors propose a new model of heterogeneous networks using Automata Theory. A network is modeled as a Push-Down Automaton (PDA) which is able to capture the encapsulation and decapsulation capabilities — features that are required for multi-layer networks where packets need to be converted between used protocols.

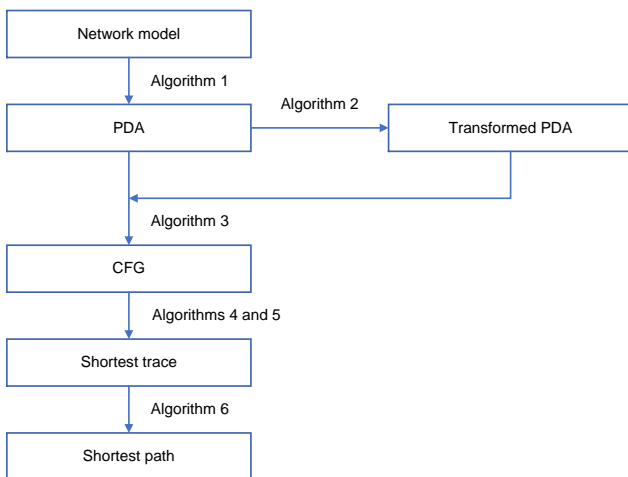

Figure 9: Procedure to compute the shortest feasible path [41].

Figure 9 presents the proposed approach. It shows stages that finally lead to the shortest feasible path. Six algorithms are proposed to enable transition between stages.

The approach provides polynomial algorithms that compute the shortest feasible path, which is defined as a) the path with the lowest number of hops, or b) the path with the lowest number of encapsulations and decapsulations. The first objective is straightforward. The second one is motivated by the fact that it minimizes the number of configuration operations, which are often performed manually. It is also motivated by reducing the possibility of loops.

The first step is to convert a multi-domain pseudowire network into a PDA. If the goal of the procedure is to minimize the number of encapsulation and decapsulations, the PDA is transformed to bypass the passive functions (i.e. no protocol adaptation). If the goal is to minimize the number of hops, the PDA is left unchanged. Afterwards, a Context-Free Grammar (CFG) is derived from the PDA or the transformed PDA. Finally, the shortest word is generated by the CFG, from which the shortest path is identified.

The paper presents mathematical analysis, describes algorithms and shows proofs of their correctness as well as complexity analysis.

In [43], the authors extend their work to address three cases:

- path computation without bandwidth constraint,
- path computation under bandwidth constraint,
- path computation under additive QoS constraints.

For the first case, the authors managed to decrease the complexity of previously developed algorithms. Through simulations, it is shown that current set of algorithms outperform previous approach. For the second case, several time complexity results were obtained and efficient heuristics were proposed. Finally, one new algorithm is proposed to resolve the third case.

4.3. QoS-aware multi-path TCP for Software Defined Optical Networks

Software Defined Networks are also envisioned for the management of Optical Burst Switching (OBS) networks. OBS is a concept that poses a bridge between currently used optical circuit switching and envisioned for future optical packet switching. It provides a compromise between these two technologies making it less demanding in terms of optical switching technology.

The paper [46] provides an extension to previously proposed scheme by the same authors, called QAMO: QoS Aware Multipath TCP for OBS Networks [44]. The former design aimed at achieving QoS in OBS networks with the utilization of Multipath TCP (MPTCP). Here, the architecture is extended by adapting it to the centrally controlled environment of SDN. The proposed architecture combines the usage of multiple paths via MPTCP and resource reservation in OBS to provide an adaptive and efficient QoS-aware mechanism.

The goal is to provide a preferential treatment to time sensitive shorter flows to achieve an expected performance for data center applications. The proposed algorithm provides priority to latency-sensitive flows at two levels, i.e. during the MPTCP path selection stage and during the OBS wavelength reservation stage.

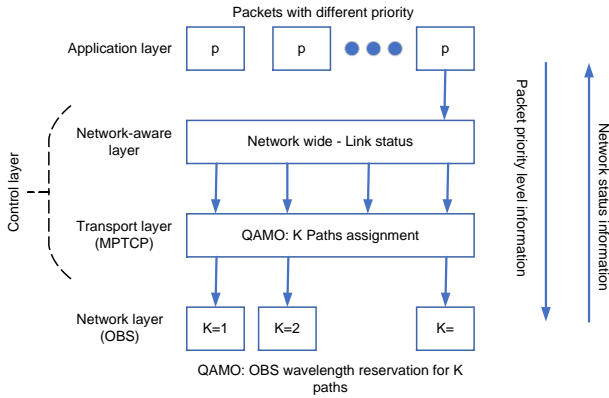

Figure 10: QAMO-SDN: cross-layer design [46].

The paper presents an algorithm called QAMO-SDN that achieves adaptive QoS differentiation based on current network feedback. Figure 10 illustrates the design. The application layer generates flows and priority level information related to each one of them. The Control layer gathers information on underlying network topology and link congestion statuses. This layer also calculates the best path for new bursts based on their priority level and current network situation.

Information regarding flow priority is passed from the Transport layer to the Network layer during OBS burst segmentation process. The current burst priority, can be easily passed from one OXC to the next and does not require any significant resources in the OXCs.

In the paper, QAMO-SDN has been validated on the simulation testbed using data center network topologies,

such as: FatTree and BCube. It is shown that it can provide QoS differentiation without negatively impacting the overall throughput of the system. It is also observed that QAMO-SDN performs slightly better than basic QAMO due to SDN architecture.

4.4. QoS-aware Network Operating System for SDN with Generalized OpenFlow

In [45] it is shown how an end-to-end QoS can be provided in a multi-layer SDN environment. The authors propose a QoS-aware Network Operating System (QNOX) for SDN with Generalized OpenFlow. QNOX adds multi-layer QoS support for Network Operating System (NOX) [47] — the first OpenFlow controller. To realize multi-layerness, a Generalized OpenFlow (GOF) is proposed.

GOF is an extension to OpenFlow that allows multi-layer control. A GOF switch provides actions for MPLS-TP and WDM/Optical networking in the Generalized Multi-Protocol Label Switching (GMPLS) networking concept on top of standard IP networks.

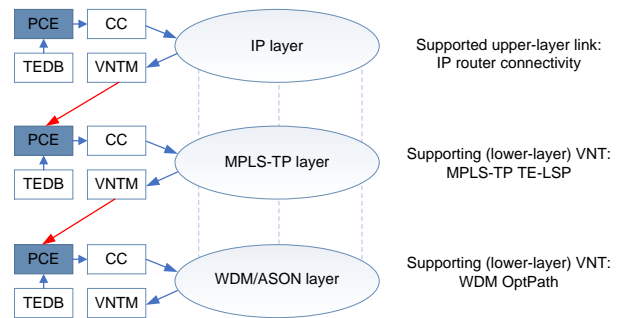

Figure 11: Multi-layer overlay networking in QNOX [45]. Path Computation Element (PCE), Virtual Network Topology Manager (VNTM), Traffic Engineering Database (TEDB), Connection Controller (CC).

Figure 11 depicts multi-layer networking as provided by QNOX. There are three layers, i.e. the IP layer, the

Table 3: Summary of surveyed dynamic QoS-aware resource allocation mechanisms.

	Goal	Optical technology	QoS	Path computation
ACINO	Application-based multi-layer services	DWDM, EoN	QoS needs taken into account during path computation	During multi-layer resource allocation
Felix et. al. [39]	Dynamic transport resource allocation for bandwidth on demand, congestion control of packet services	D(WDM)	Resource allocation according to optimal capacity needs	Optimal path for the end-to-end circuit
AHB [40]	Dynamic optical resources allocation	D(WDM)	Dynamic bypasses	During the bypass setup
Pseudowire MLN	Multi-layer services	D(WDM)	QoS needs taken into account during path computation	Dedicated bandwidth and QoS constraints
QAMO	QoS in OBS	OBS	Resource reservation from OBS and MPTCP	Not defined
QNOX	End-to-end QoS in multi-layer environment	D(WDM)	GMPLS	PCE

MPLS-TP layer and the optical layer. Each one can be asked to find a path between two given endpoints. Therefore, each layer employs a Path Computation Element (PCE) component. Virtual network topology manager controls the topology of each layer and cooperates with PCE of a lower layer. PCE is also fed by traffic engineering database (TEDB). Finally, PCE requires a connection controller (CC) to invoke signaling inside the network.

The presented framework allows to steer the QoS in various layers. The network QoS monitoring functions are implemented at ingress and egress nodes. The monitored parameters include delay, jitter, packet loss, and packet error.

The authors analyzed the scalability of QNOX through a series of experiments. The obtained results show that QNOX provides network resource discovery in less than a second, calculate routes for a network of 100 nodes in less than 100 ms, and provides fault notification and fault restoration in less than 60 ms. This shows that QNOX is applicable for carrier grade large scale networks.

The summary of dynamic QoS-aware resource provisioning mechanisms is provided in [Table 3](#).

5. Multi-layer protection and restoration

Due to availability requirements of networks' services, a resilience is an important issue, which should be guaranteed by telecommunication operators. Hence, proactive (protection) as well as reactive (restoration) mechanisms have been widely discussed.

The issue of resilience for SDN has been deeply analyzed in literature. SDNs, like all other networks, need to be resilient to faults and operate in a stable way. Adding a controller to a typical IP networks results in new potential failures, e.g. OpenFlow failure, breaks in controller operations. There is a necessity to propose solutions to manage the resiliency problem as a whole. One of possible resilience management mechanisms is described in [61]. The authors present the framework to orchestrate the individual resilience services implemented as OpenFlow applications. The proposed mechanism is responsible for coordination of resilience approaches like detection of attacks and anomalies, bandwidth monitoring systems, load balancing. As each of them should be resilient, the coordination of all strategies is also necessary.

The analyses of SDN resilience is usually a part of surveys related to SDNs. In [62] one of sections describes possible solutions which improve network resiliency in SDNs. In this section, resilience issues, solutions, and challenges are highlighted. The overview of the resilience-related issues for SDNs is also presented in [63], [64] and [65]. The last two of cited papers are directly related to resiliency analysis and fault management. In both papers, the controller placement problem is analyzed. This is an important issue when planning the SDN. The implementation of only one controller may be insufficient for complex networks. In some cases it is necessary to use more than one controller for efficient and more reliable network management. The controller placement problem takes into account how many controllers should be used and where they should be implemented. The proposed solutions are based e.g. on estimating a metric concerning the invalidation of nodes, links, and connectivity between controllers and switches and min-cut-based graph partitioning algorithm

based on it [66]. Another metric is presented in [67]. In [68] a graph is used to analyze the cascading behavior of a failures.

In this section, we review resilience strategies in SDN-based multi-layer optical networks. In Figure 12 the scheme presenting the structure of this section is presented. This section is composed of three subsections. In two first of them, we analyze solutions for link and node protection in multi-layer SDN. Finally, additional proposals are presented. Among them we point out solutions based on transport of traffic in different multi-layer SDN architectures based on optical layer.

5.1. Resilience in case of link failures

Important topic is related to resilient mechanisms against link failures. In [48], the cross-layer restoration path is proposed for detected fiber cut in IP over Optical Transport Networks (OTN). In the proposed solution, centralized controllers with layered hierarchy (hierarchical controllers) are used. This control plane contains unified controllers (UCs) and transport controllers (TCs). UCs control routers in the IP layer and communicate with TCs which interact with optical nodes. One should note that issue of SDN controllers in multi-layer environment is carefully addressed in Section 6 while below we focus solely on the resilience aspects.

In the case of a fiber cut, a transport controller can setup a new lightpath or cooperate with the unified controller to optimize the routes for restoration. Through numerical simulations, the proposal achieved lower service blocking rate in comparison to a reference case. In addition, the proposed resilient solution was demonstrated in a testbed with the OpenFlow protocol. This cross-layer restorations can recover from high degrees of failures, such as multi-point and concurrent failures. Unfortunately, such a hierarchical control technique can result in long restoration times.

In [49], the authors propose the Survivable Automatic Hidden Bypass mechanism to deal with an optical link failure. Figure 13 shows a traffic handling procedure after a failure. In a case of failure, after dropping all of

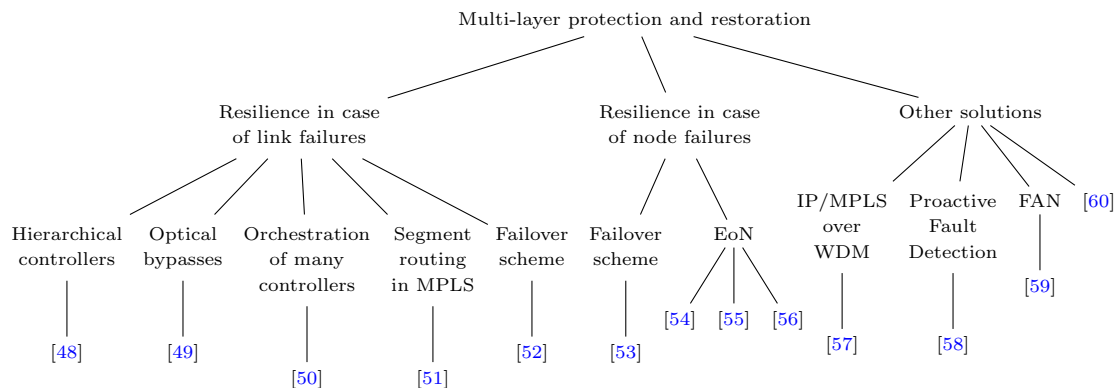

Figure 12: Structure of the Section 5.

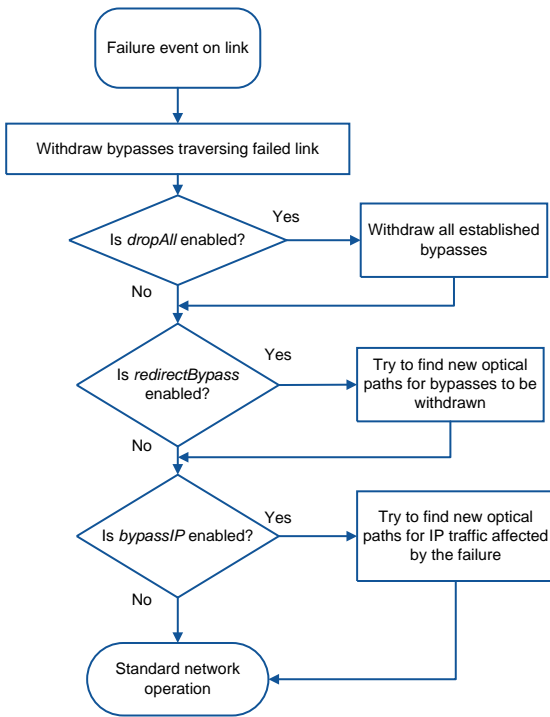

Figure 13: Survivable Automatic Hidden Bypass [49].

the bypasses in the network (*dropAll*), new lightpaths are searched for traffic (*redirectBypass*). To find them, pre-computed lists of new bypasses are considered. Next, a bypass is created for the IP traffic affected by the link failure (*bypassIP*). For the time needed to establish a bypass, the IP layer handles all the traffic and new bypass requests are blocked by the SDN controller. After setting a bypass for the IP traffic the controller starts to handle new bypass requests again.

Authors of [50] present a multi-layer restoration plan. The plan determines which and in what order connections should be restored in case of a possible failure. The key element of this system is the orchestrator which is responsible for coordination of many controllers. Multi-layer restoration was demonstrated in Telefonica’s + D/GCTO lab for Dense WDM link failures. The presented solution achieved 54% lower traffic loss compared to optical restoration.

Another possible solution to solve problems with network element failures is Segment Routing. In paper [51] the Segment Routing-based approach with superimposed Software-Defined Networking is proposed. It allows to utilize the remaining optical capacity in case of a link failure (fiber cut) in an effective way in multi-layer carrier networks. The authors of the paper have noticed that after a failure, optical devices restore the same topology which is known at the IP layer using longer light-paths. Unfortunately, this can affect the optical capacity of the link. However, in such situations, usually capacities visible at the IP layer change. While this layer is not able to serve

traffic in links with fluctuating capacities, such links are shut down very often. The problem is observed in carrier networks, where at the packet layer, the MPLS-based routing is used. In such networks, to facilitate redundancy and load balancing, the ECMP (Equal Cost Multi-Path) is implemented. As a result, variable link capacities observed after failures raise two problems in the packet layer:

- IP layer might not notice bandwidth limitation (which is not observed at the optical layer),
- if IP layer notices bandwidth limitation, ECMP is not able to set different weights for links.

Currently, the problem is that after a failure, the offered load needs to be reduced entirely for all parallel links. Alternatively, restored links with smaller available capacities need to be disabled for transmissions. Only such techniques avoid overload, however, the effect of their implementation is usually the under-utilization of available capacity in the optical layer.

To solve the mentioned problem, the authors of [51] have proposed the implementation of Segment Routing in an MPLS router and the SDN functionality over MPLS in edge routers. When link capacities change at the optical layer as a result of traffic paths reconfigurations, it is reported to the central controller at the control plane. The controller is able to split the incoming traffic into smaller flows if it is imposed by bandwidth reduction of links on the path. The Authors of the mentioned paper indicate, however, that currently available SDN controller software is not advanced enough to meet the requirements of MPLS. As a result, the implementation of SDN needs to be gradual and minimally invasive to keep the reliability, resilience, and trust in existing carrier network at the acceptable level. Thus, it is proposed to implement SDN control only on selected nodes. Such nodes are those through which sufficient network traffic is transmitted, which allows for the compensation of capacity reductions.

The main components of the proposed system are presented in Figure 14

During the normal operations (without failures and errors) the SDN controller is not used. Traffic is served using segment routing and MPLS. On the other hand the controller needs to take into account the following states after a failure:

1. The reduced capacity on the link is sufficient to handle the traffic; no action is required.
2. The reduced capacity is not sufficient to handle the traffic and the SDN control over the affected traffic is:
 - (a) sufficient to compensate the capacity reduction. The SDN controller superimposes the MPLS decisions and reroutes the traffic.
 - (b) not sufficient to compensate the capacity reduction. In this case the impaired link is disabled.

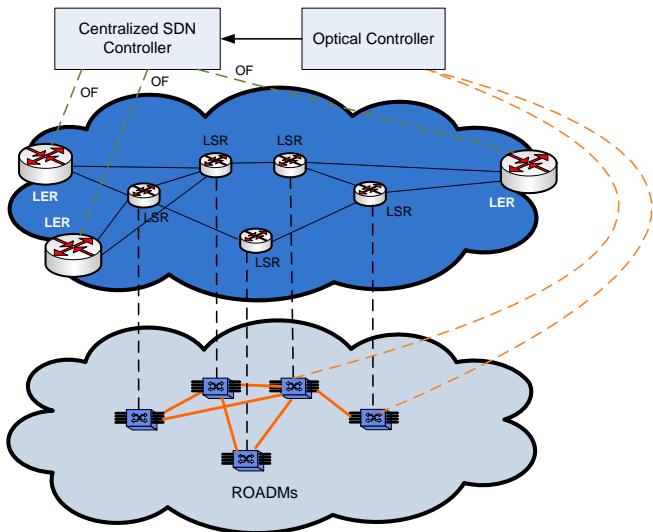

Figure 14: System main components [51].

The key SDN controller functionality of the algorithm is to select flows to be rerouted. The proposed system with different algorithms has been tested using the German carrier topology with its actual traffic matrix as well as a worst-case traffic matrix. Based on the presented results, one may conclude that superimposing SDN over an existing carrier network is a promising approach to implement new features in the network. At the same time, it is possible to minimize network impact on the reliability characteristics.

To re-route traffic flows affected by a network element failure, the authors of [52] employ Segment Routing (named the Segment Routing Failover scheme). During the initialization phase, nodes are pre-configured against failures. When a failure occurs, the traffic is locally rerouted to backup paths from the node detecting the failure up to the node indicated in the last label of the segment list. The proposed solution was evaluated in a simulation environment and experimentally implemented in an SDN-based testbed. In the testbed, the SDN RYU controller was implemented, whereas OpenFlow was utilized for the communication between the controller and the nodes. It was reported that the average recovery time was equal to 42 ms.

5.2. Resilience in case of node failures

Another problem in a network can be a node failure. The paper [53] investigates the Segment Routing Failover scheme under the assumption of node failure in multi-domain multi-layer SDN networks. Mentioned work [53] is extension of previous paper [52].

In [54], [56] and [55], the authors propose resilient solutions in case of an optical node failure in the IP over EoN (Flex-grid) networks. Specifically, a failure of a lightpath

edge node is considered in the OpenFlow-enabled multi-stratum (multi-layer) EoN network. Restoration path utilizes existing resources at IP and resources of a newly established lightpath in inter-data center networks. In [56], the auxiliary graph is employed for resilience. The graph is created according to the current multi-layer network state. Calculated edge weights reflect the utilization of network resources, i.e. the processing capacity of IP routers, the congestion degree, the cost of E/O or O/E conversions, the optical spectrum fragmentation ratio. Based on the graph, the shortest path is selected from source to destination. However, the alternative data center servers are not considered for case of heavily loaded IP layer.

The alternative data center servers can be chosen for resilience in [54] and [55]. After detecting a problem, the optical controller recognizes the type of a failure based on the place where it occurs. For an intermediate node failure, a resilient service is ensured in the optical layer, whereas for the failure of a lightpath edge node, the proposed solution finds a new edge node and a lightpath. Using the IP layer, the traffic is transferred to a new lightpath edge and then it is sent all optically to the end node. Restoration paths are calculated based on available resources. Alternatively, new data server is chosen when the IP layer is heavy loaded. In the presented systems, each layer is controlled by a dedicated entity, which cooperates with other controllers.

Through numerical simulations, the efficiency of hybrid paths is proved in [54], [55] and [56]. These solutions achieve gain in terms of path blocking probability, resilience latency and resource occupation rate when compared to other resilient algorithms. Additionally, papers [54] and [55] present interworking procedures and information exchanged between layer controllers. Moreover, results of experimental verification based on Optical as a Service testbed with OpenFlow are presented in [55].

The summarized comparison of the described resilience approaches in case of link and node failures is presented in Table 4. As one can see, mechanisms recover from link and node failures have been proposed for multi-layer SDN networks. To solve network failures optical or multi-layer paths or implementation of segment routing have been consider. Most of them use testbed environments to validate proposed solutions.

5.3. Other solutions

In [57], a network planning process is presented. Especially, the resilience is considered for multi-layer architectures operating with SDN controllers. The Authors have noticed that in many cases network operators are migrating towards an IP/MPLS over WDM architecture. However, taking into account protection/restoration aspects all layers operate separately. This results in highly redundant and uncoordinated protection schemes. Considering protection/restoration aspects, IP links are usually over-estimated. The offered capacity in most cases exceeds the

Table 4: Comparison of resilience approaches in SDN networks.

Reference	Approach	Control	Recovers from	Proposed method	Multi-layer network	Testbed
Zhang et. al. [48]	Cross-layer restoration path	Hierarchical controllers	High degrees of failures (multipoint and concurrent failures)	Restoration at optical layer or cooperation with the unified controller to find optimized routes	IP over OTN	Yes
Borylo et. al. [49]	Optical bypasses	Optical controller	Optical link failures	Method establishing bypasses that will be affected by failures in minimal scale	IP over WDM	No
Maor et. al. [50]	Planning restoration	Multi-layer controller	Optical link failures	Restoration plan to determine the order of connections to be restored	IP over DWDM	Yes
Blendin et. al. [51]	Segment routing in MPLS nodes	The SDN functionality over MPLS in edge routers	Optical link failures	SDN controller superimposes the MPLS decisions and reroutes the traffic	IP/MPLS over EoN	Yes
Giorgetti et. al. [52]	Segment routing	Multi-layer controller	Optical link failures	SDN controller enables the configuration of multiple forwarding tables	IP over OTN	Yes
Giorgetti et. al. [53]	Segment routing	Multi-layer controller	Node failure	Extension of [52]	IP over OTN	Yes
Yang et. al. [54] [55] [56]	Mixed resilient path	Dedicated entity for each layer	Optical node failures	End-to-end restoration based on available resources at IP and optical layer	IP over EoN	Yes [55]

peak needs over 100% (only around 30-50% of available capacity is used in normal conditions).

In the presented paper, two advanced multi-layer resilience operations: Multi-layer Re-Route and Multi-Layer Shared Backup Router are described in details. In the first solution, resources of different layers are involved in the restoration process. In this proposal, a common pool of additional resources is used as extra transponders at all routers to restore failures by creating new IP adjacencies. The additional transponders are used when traditional mechanisms to restore traffic after a failure cannot be used. The second proposal assumes that the protection is used instead of restoration. It is assumed that routers are duplicated at each layer to protect against equipment failures. When a router failure is observed, configuration from the failed router is copied and written to the shared backup router. Moreover, connectivity to other routers is restored via multi-layer provisioning operations.

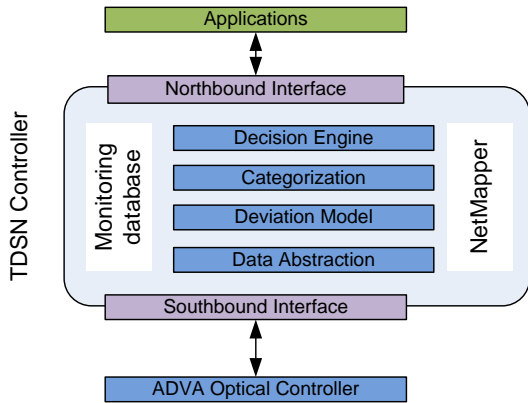

Figure 15: TSDN system architecture [58].

Finally, the Authors compare the SDN concept with UNI (User Network Interface) control plane and PCE. They conclude that the SDN can consume the benefits of the PCE architecture. Moreover, the implementation of SDN can enable the support for multi-layer schemes in real networks.

In [58] the authors introduce the concept of cognitive fault management. They propose this solution for transport networks with an SDN controller as a central point and prove its correct operation based on real-world fault examples. The proposed solution detects and identifies significant faults and outperforms conventional, usually used, fixed threshold-triggered operations, both in terms of failure detection accuracy and proactive reaction time.

The system architecture is presented in Figure 15. The Proactive Fault Detection (PFD) module is located within the Transport SDN-integrated (TSDN) controller. The data is monitored all the time and stored every 15 minutes through the southbound interface using NETCONF. As authors declare, the engine of the system performs fault detection and generates fault layer information (by mapping the metadata), fault locations, and maps the machine learning outcome to an internal decision engine followed by respective application. As was shown by the evaluation, the proposed solution allows for simpler network management. Moreover, it improves the fault response time, compared to conventional threshold-based failure detection. This is the effect of applied machine learning, which is gaining momentum in optical networking industry.

The paper [59] describes the concept of Flow-Aware Networking (FAN) in a multi-layer SDN-based system. In original FAN traffic management is decentralized and each network node operates independently. The proposed solution integrates FAN with the SDN controller, which is implemented for centralized fault and congestion man-

agement. The Authors propose to use a complex system which integrates not only FAN and SDN, but also dedicated mechanisms proposed for FAN:

- EHOT – Enhanced Hold-Off Timer – the mechanism which ensures coordination between IP and optical layers when failure occurs,
- intelligent routing – a method for multipath routing,
- SCCM – Simple Congestion Control Mechanism, which ensures short acceptance times for priority flows,
- GPFL – Global Protection Flow List used for flows redirections in case of failures.

The system architecture is presented in Figure 16, where particular layers are presented. The simulation evaluation described in the paper confirms the usefulness of the presented approach and its positive aspects in relation to fault

management in cross-layer network architectures centrally managed by an SDN controller.

In [60] the authors propose a solution to support reliability for power grid applications. They concentrate on optical protection switching for the resilience of SDN control. The cascaded failures were studied in static and dynamic (with reconfiguration of the physical layer) optical layer. Simulation results showed that, failure cascades are dependent on the network topology for static optical layers. In the scenario of a dynamic optical layer, 73% of failure cascades were suppressed.

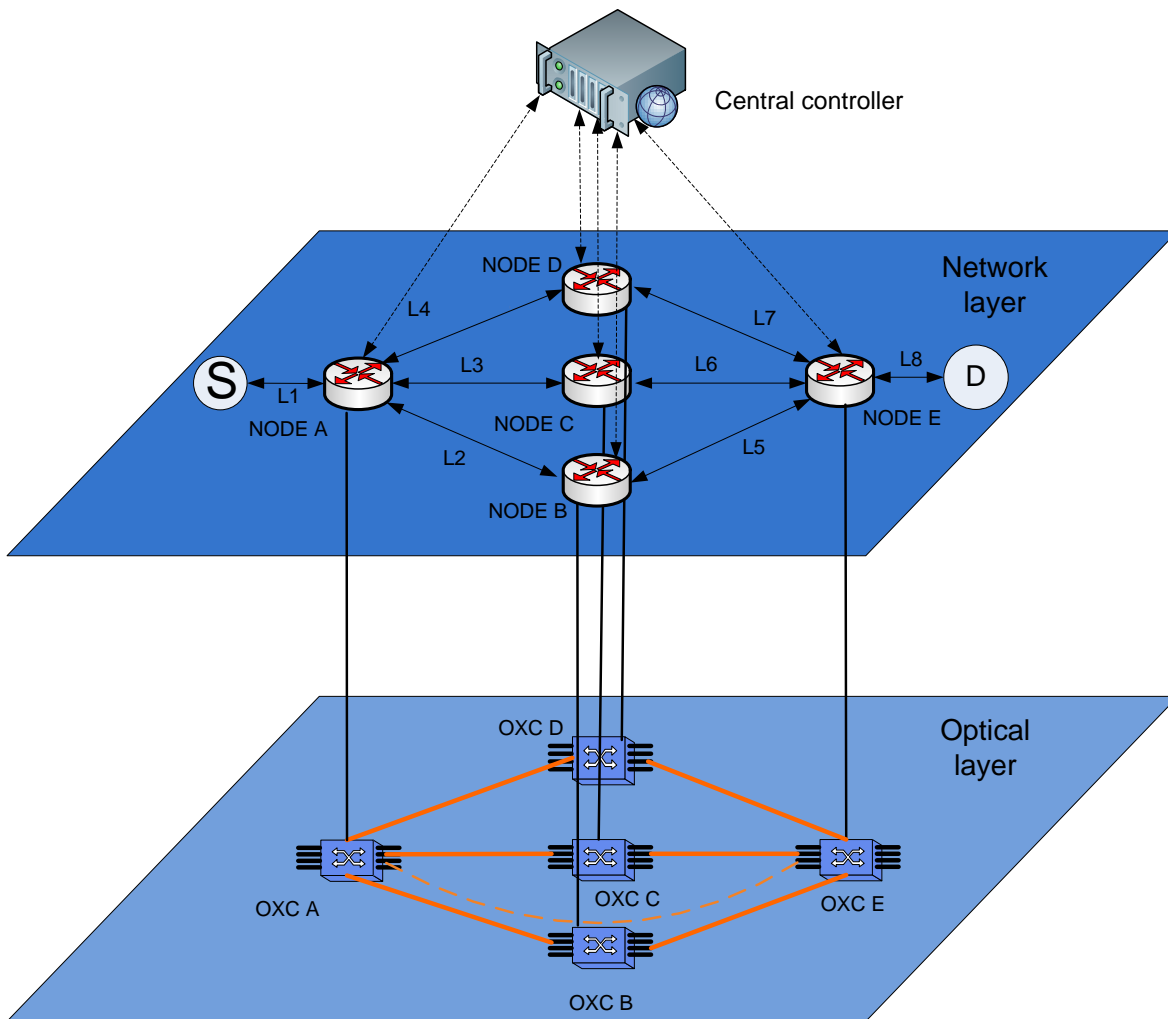

Figure 16: FAN-SDN system architecture [59].

6. Multi-layer SDN controllers, orchestrators, emulators and testbeds

Concepts and algorithms, presented in previous sections, are a crucial part of multi-layer SDN networks, but they are not sufficient. Programs and tools, which enable their usage and implementation are equally important.

This section presents current ecosystem of controllers, orchestrators, emulators and testbeds for multi-layer SDN networks.

Controller is a brain of any SDN system. In case of multi-layer or multi-domain networks, multiple controllers are often necessary. This is due to lack of interoperability between multiple vendor devices or specificity of different layers. These controllers need to be coordinated which is the task of an orchestrator. In other words, an orchestrator is a *controller of controllers*.

Any software system, including SDN, needs to be tested during development. Emulators can run unmodified controllers and applications on virtual networks, allowing rapid development. In order to evaluate the system performance, it may be also necessary to test in on real hardware. Testbeds, built of hardware switches, provide an environment for that.

6.1. Controllers

Numerous SDN controllers have been implemented by both open source projects and companies from the ICT sector. However, only few of them have been considered regarding the multi-layer networks.

6.1.1. Commercial solutions

One of the commercial solutions was proposed by Juniper Networks and is denoted as NorthStar Controller [69]. In order to address the identified market need for packet-optical coordination between transport and IP and MPLS layers they proposed a solution based on the controller-to-controller communication interface. Such an approach is, according to the producer, much simpler than the architecture where the control of both layers is integrated within a single entity. Numerous impediments are

mitigated, e.g. requirements on protocol and vendor interoperability, the need for coordinated maintenance, or routing state synchronization between layers. Instead, proposed interface is expected to ensure simplicity and scalability.

The NorthStar Controller is a software entity that can be run on any suitable x86 hardware platform. Its main responsibility is to collect information about network paths from routers based on the RFC5440 and build comprehensive knowledge about network topology utilizing either BGP-LS or OSPF/ISIS-TE. Extending the NorthStar Controller with the interface to optical layer allows also to collect information about the transport network. As a result multi-layer optimization and resource provisioning can be conducted in a centralized manner. In the [69] the following use cases are described: multi-layer network topology visualization, deployment of disjoint paths in the network to ensure transmission survivability, as well as multi-layer protection and restoration. Simultaneously, more advance scenarios are network defragmentation, rerouting for synchronized multi-layer network maintenance, or finally, scheduling of future request expected in the network.

Another commercial solution was proposed by the Sedona company in a product denoted as NetFusion Packet/Transport Network Intelligence and Automation¹. One of the features regards the fact that multi-layer is considered not only as packet-optical integration but also as, so called, *service-to-fiber* approach. The general principle is similar to the one assumed by NorthStar. Namely NetFusion controller is placed on top of other controllers deployed in the network. In this way producer wants to integrate multiple layers, vendors and domains. For example, both core and aggregation IP networks, as well as both metro and long-haul optical networks. Data gathered from various layers will be utilized by the SDN control plane to optimize resource provisioning in network layers from 0 to 3. Such a solution enables simplified transition from legacy solutions present in current infrastructure to the SDN architecture. Furthermore, the portfolio of use cases that can be deployed in the NetFusion framework was proposed. Solutions are grouped into two categories: Intelligence Apps

¹<https://sedonasys.com/multilayer-networking/>

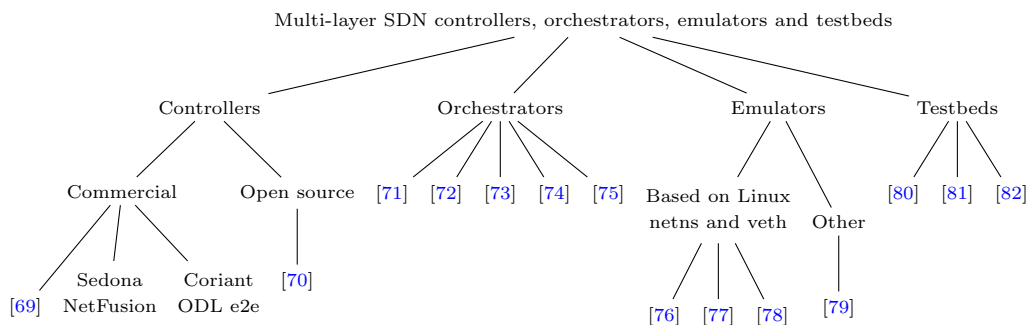

Figure 17: Structure of the Section 6.

and Automations Apps. The former creates a possibility to collect metrics and data about network elements, while the later is focused on utilizing this data to optimize resource utilization, ensure network survivability, and automate resource provisioning. Automation Apps are therefore equivalent to the use cases proposed for NorthStar controller. Sedona representatives also claim that their solution is able to integrate with controllers developed by different vendors. Parts of the NetFusion product are result of H2020 EU project called ACINO (Application-Centric IP/Optical Network Orchestration). It shows potential of R&D projects being conducted under the industry and academia partnership. Value of the resulting product is confirmed by the fact that Verizon announced using NetFusion technology in its core network.

One must note that the NorthStar and NetFusion controllers are not independent multi-layer solutions able to communicate with devices operating in different layers. Instead, those products are rather orchestrating other controllers handling different layers and domains. On the contrary, a solution proposed in [39] communicates with various devices in order to ensure network control for packet-optical networks. Also for this product some use cases were considered. The first one aims at optimization of bandwidth utilization when providing packet-optical services. The second, controls congestion in multi-layer network based on the statistical multiplexing.

The platform was built as an extension of OpenDaylight², which is one of the most popular open source SDN controllers, and Optical Network Control platform, which is a commercial framework. The proposed solution has hierarchical architecture to address multi-layer nature of underlying network. Upper layer controller (ODL extension) handles Ethernet (end-to-end) services and lower layer Transport Cloud controller provisions resources in optical domain. As original ODL is able to communicate only with packet-layer devices it was extended with components enabling control of circuit switched technologies. NETCONF and OpenFlow protocols are used for the purpose of communication between ODL and packet devices, while original OpenFlow+ protocol (extending standard OpenFlow) ensures communication between ODL and Transport Cloud controller. The principle of the proposed OpenFlow+ is to abstract optical network as an electric-layer switch exposing only its interfaces and hiding internal architecture of the optical transport network. Finally, Transport Cloud controller was built as an extension of the commercial product denoted as Coriant Intelligent Optical Control designed to handle devices operating in L0-L1. The framework was designed by Coriant and AT&T employees, and thus it is expected that final product addresses customer needs.

²<https://www.opendaylight.org/>

6.1.2. Open source (ONOS platform)

Beside OpenDaylight, one of the most popular open source controllers is the ONOS platform³. The architecture of ONOS enables to create a control plane handling both packet and optical network layers in multi-vendor infrastructure. A Proof of concept (PoC) of such a control plane was presented in [70] by a consortium of renowned companies (e.g. AT&T, Ciena, Fujitsu, Huawei, Corsa, and Spirent). One of the biggest advantages of the proposed PoC is fact that real hardware was used in both packet and optical layers. Similarly to previous controllers, also in this case, examples of applications have been deployed: Bandwidth on demand, Multi Layer Network Optimization, and Advanced Multi-Layer Restoration. Due to the integrated nature of the proposed solution each application is able to impact any network layer. Furthermore, a system is able to respond autonomously in seconds which is crucial for applications running in real time. Technically speaking, ONOS controller is able to adjust capacity of tunnels in the electric layer, ensure restoration in the optical layer, and deploy multi-layer tunnels. Variety of protocols and devices in multi-vendor environment is also abstracted using OpenFlow, TL1, and PCEP.

The ONOS architecture is based on intent framework, where intent denotes immutable object describing application request to modify the network state. Intents provide abstraction at all layers of ONOS architecture. Therefore, intents are translated into the network resources involved in handling a particular request, traffic flows descriptions, or actions to be performed on those flows. Finally, each intent is directly translated into the commands expressed in proper protocol. It enables communication of the ONOS controller with variety of network equipment. An intent-based approach has been utilized in collection of works [83], [84], and [85] aimed at creating secure services in multi-layer SDN infrastructure. Secure service is denoted as connection established for the purpose of encrypted communication. The authors proposed an algorithm which automatically selects the encryption mechanism based on the application requirements expressed using intents. Also in this case the solution was validated using commercial hardware combined with the modified ONOS controller.

The ONOS controller and intent-based approach were also used in the context of integration between network control and network planning planes (open source Net2Plan platform). The aim was to optimize multi-layer networks [27]. Both entities take advantages from such an integration. Namely, ONOS is able to effectively re-route paths and optimize network utilization in a network-wide manner. Simultaneously, Net2Plan feeded with information about network state can make suggestions about desired infrastructure investments and warn about consequences of potential equipment failures. The proposed solution is designed for IP/MPLS over optical networks.

³<https://onosproject.org/>

Table 5: Multi-layer SDN controllers summary.

Controller	License	Producer	Architecture	Notes
NorthStar	Commercial	Juniper Networks	Controller to controller	Utilizes RFC5440, BGP-LS, OSPF, and ISIS
NetFusion	Commercial	Sedona	Hierarchical controllers	Covers L0-L3 to provide <i>service-to-fiber</i> concept
ODL e2e	Commercial	Coriant	Direct communication	Extends OpenDaylight and OpenFlow Protocol
ONOS	Open source	–	Direct communication	Implements intent-based approach

6.1.3. Multi-layer SDN controllers summary

Described multi-layer SDN controllers are summarized in Table 5 regarding the license type, producer name, assumed architecture, and notes about implementation details. It is important to note that basically two types of approaches coexist in the context of implementation SDN controllers for multi-layer networks. One of them assumes that different controllers are responsible for different layers of network infrastructure and communicate with each other in either controller-to-controller or hierarchical manner. Second approach assumes that one controller directly communicates with devices operating in both optical and electrical layers.

A variety of devices in multi-layer and multi-vendor environments indicates that OpenFlow Protocol is not the only implementation of SDN. Protocols such as TL1, PCEP, NETCONF or even SNMP are widely utilized to ensure communication between control and data planes. On the other hand, **OPF** pretends to be an universal solution widely supported by equipment vendors and controller producers. The need for multi-layer networks support was reflected by Open Network Foundation in OpenFlow Protocol ver. 1.4⁴ which enables configuration of optical ports. It allows to configure physical layer parameters such as, for example, optical power or wavelength. However, this solution is not fully mature and further improvements are expected. The most important impediment regards the discovery of optical layer topology and configuration of optical connections. Solving all of those issues is expected to help engineers to implement SDN controllers supporting multi-layer network architectures. Only approach approved by the network equipment vendors and producers of controllers can be successfully implemented in the global-wide perspective.

6.2. Orchestrators

The central control system is necessary for networks that comprise multiple administrative domains, multiple layers (in particular optical and IP layers), and multiple vendors at all layers. It could be really hard to efficiently manage a multi domain optical network. In most cases, each domain is managed by a separate controller which does not have knowledge of other controllers. That is why an orchestrator or a central multi-domain controller that

has the view of all domains and is capable of querying their respective controllers before setting up the connection is desirable.

The authors of [71] notice that a central controller is even more necessary in multi-layer environments, where changes at the IP layer need to be coordinated with all optical domains. It is hard to optimize traffic at the IP layer in a distributed way when some new links need to be added or removed and all these operations need to take into consideration that at the optical layer traffic is sent through many domains managed by different operators.

Finally, it has been stated that central controlling plays a more active role for non-real time tasks such as network optimization, or reversion back to normal after the failure has been fixed. In such operations, central controller will orchestrate the process and ensure it takes place in a hitless fashion, when traffic conditions allow for it. On the other hand, under real time operations, distributed management can be more efficient, e.g. when failures need to be solved. That is why the authors suggest that it will be more efficient to build a hierarchical central control architecture: single layer controllers at the bottom, an orchestration platform connected to their northbound interfaces (NBI) in the middle, and multi-layer applications on top. Such an architecture had been analyzed through the experimental demonstration. It was shown that the coexistence of separate controllers with the orchestrator allows for efficient traffic management.

In [72] the authors also propose to implement an orchestrator to manage traffic in IP-optical networks. The key argument is that traffic at the optical layer should be managed on a per-application basis. To do this, the authors suggest to exploit the flexibility provided by Flex-Grid technology and the joint orchestration of IP/MPLS and optical resources.

A novel approach ACINO is able to groom flows of applications with similar quality requirements or to place application-specific traffic flows directly into dedicated optical services. Nevertheless, there is the necessity to manage such flows to enable applications to meet their specific requirements and to reserve proper network resources for such flows. For example, in the paper, it is suggested to solve failures at the IP layer only for latency-sensitive flows, while for other flows restoration should be realized at the optical layer. It has been explained that IP layer hardware latency in core routers is very small. On the other hand, at the optical layer the latency is dominated by light propagation. The authors demonstrated that the

⁴<https://www.opennetworking.org/software-defined-standards/specifications/>

proposed model works in IP-optical domain with tunnels reserved using MPLS and managed by an orchestrator taking control over two or more distinct controllers for IP and optical devices. On the other hand, some further work is necessary to optimize the mechanism and to develop an interface to allow applications to specify their needs and to develop the orchestration algorithms that can translate these needs into an implementation to optimally fit the network.

The authors of [73] present a concept of SDN/Network Function Virtualization (NFV)-based orchestration architecture for Mobile Network Operators (MNO). The goal is to enable coordination of the virtualization of heterogeneous transport technologies within the aggregation segment and to compute cloud resources at the data centers. The proposed SDN/NFV orchestration architecture providing MNO backhaul virtual networks is presented in Figure 18.

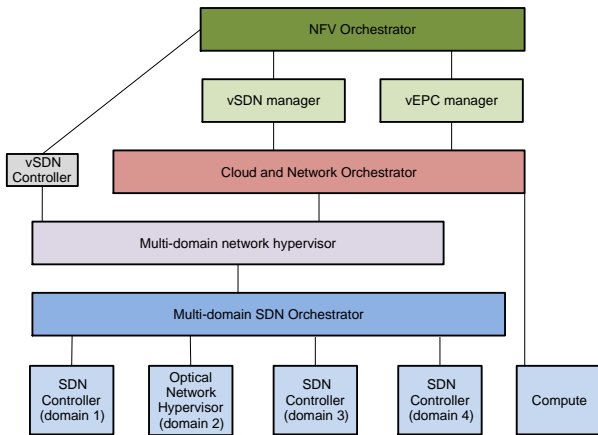

Figure 18: SDN/NFV orchestration architecture providing MNO backhaul virtual networks [73].

At the top of this architecture, the NFV orchestrator is implemented to coordinate operations of SDN and EPC managers. The Multi-domain SDN Orchestrator is a system (unified for transport network) handling the composition of end-to-end provisioning services across multiple domains of the aggregation network at an abstract level. This controller is based on the IETF ABNO implementation. Multi-domain Network Hypervisor is responsible for partitioning and aggregation of the physical resources (nodes, links, etc.) in each domain into virtual resources and for interconnecting them to compose MNO virtual backhaul tenants. Cloud and Network Orchestrator ensures coordination and management of cloud resources (virtual machines, VM) and network resources in the multi-layer infrastructure.

The authors of the paper conclude that the proposed architecture allows for better adaptation of the MNO capacity needs, which increase rapidly. The system ensures

more efficient use of the backhaul resources as a result of the SDN/NFV orchestrator coordination in a multi-layer aggregation network.

In [74] an SDN orchestrator is proposed. It ensures two functions in an Ethernet-over-Wavelength Division Multiplexing (WDM) network: on-demand flow provisioning at the Ethernet layer and coordinated fault handling at both the Ethernet and WDM layer. As a result, the orchestrator is responsible for automatic provisioning of optical circuits to efficiently satisfy the Ethernet flow fault-tolerant requirement. Moreover, it coordinates response procedures at both layers, which allows to quickly re-route disrupted flows. Finally, it is ensured that the network is prepared to handle a potential second outage. The proposed orchestrator is built based on four components: database and Resource Management, Service Provisioning, and Service Protection and Restoration modules. The Resource Management module is responsible for constant communication with optical and Ethernet devices through Rest APIs provided by the Ethernet controllers. Moreover, it uses the RESTCONF Optical plugin to discover the nodes and the topology and to store them in the database. This database holds information about the network topology and the state information of both the Ethernet and WDM networks. The Service Provisioning and Service Protection and Restoration modules cooperate with one of the open source OpenFlow Ethernet controllers and one optical plugin to set up/tear down traffic flows within the network. The authors of the paper experimentally tested the proposed approach and concluded that it can discover the topology of the network in both layers and compute two disjoint paths between the end-points of incoming requests. Moreover, it has been presented that the fault-handling is a cooperative action between proactive (protection) and reactive (restoration) approaches and the recovery times are fully acceptable.

In [75] it has been explained that the typical multi-layer architectures, based in most cases on the IP/MPLS layer over an optical infrastructure (WDM, OTN, etc.) require also a network programmability layer that enables the control and management of the resources at both layers (IP and optical). The architecture proposed in the paper assumes that the multi-layer network programmability approach allows to positively answer to needs of both layers. The authors assumed that the binary protocols improve the performance at the low levels on the network, while RESTbased APIs enable a faster development and network interoperability. The proposed architecture, based on this assumption, is the Open Source Netphony suite. It is composed by a GMPLS control plane, which enables to emulate the network elements control, a Path Computation Element with active and stateful capabilities, a Topology Module capable, which enables to import and to export TE information in different protocols and an Application-based Network Operations (ABNO) controller. The experiments conducted by the authors lead to the conclusion that the proposed framework enables multi-

Table 6: Comparison of SDN-based multi-layer orchestrators.

	Gerstel et. al. [71]	Gerstel et. al. [72]	Martinez et. al. [73]	Mirkhanzadeh et. al. [74]	Lopez et. al. [75]
Approach	Orchestrator for SDN controllers	ACINO	SDN/NFV-based orchestration architecture for mobile network operators	SDN orchestrator to quickly re-route of flows	Open Source Netphony suite
Control method	Hierarchical central control architecture	Orchestrator taking control over two or more distinct controllers for IP and optical devices	NFV orchestrator coordinates operations of SDN and EPC managers	Orchestrator responsible for automatic provisioning of optical circuits to efficiently satisfy the Ethernet flow fault-tolerant requirement	Multi-layer coordination between IP and optical layer
Solves the problem of	Uncoordinated multi-layer and multi-domain control	Uncoordinated control	Coordination of the virtualization of heterogeneous transport technologies within the aggregation segment	How to quickly re-route of disrupted flows	How to control and manage of the resources at both layers (IP and optical)
Proposed method	Single layer controllers at the bottom, orchestration platform in the middle, multi-layer applications on top	Solve failures at the IP layer only for latency-sensitive flows, restoration at optical layer for other flows	Multi-domain SDN Orchestrator based on the IETF ABNO implementation	On-demand flow provisioning at the Ethernet layer and coordinated fault handling at both the Ethernet and WDM layer	The binary protocols improve the performance while REST-based APIs enable a faster development and network interoperability

layer programmability for IP and optical networks.

The summarized comparison of the described approaches is presented in Table 6. As we can see, there are different control methods which can be used to manage the operations of orchestrators. The orchestrators can work under control of hierarchical model or many controllers. NFV controllers can be used or multi-layer coordination can be applied. Orchestrators can solve some problems with uncoordinated control of resources and ongoing flows. The presented mechanisms can also minimize undesirable effects of failures, protect flows or improve their performance.

6.3. Emulators

Testing is an inherent part of developing any software system. This includes SDN systems and algorithms. They have to be tested to ensure correctness of operation and performance. Emulators allow to run SDN control plane on virtual networks with arbitrary topologies. They run unmodified controllers and applications, unlike simulators, which must be specifically programmed to evaluate particular algorithm and employ many simplifications.

Mininet is the most popular SDN network emulator. It emulates virtual networks in the Linux system, using network namespaces (each containing its own instance of a network stack), connected with virtual Ethernet links. Mininet does not facilitate emulation of multi-layer networks — it needs to be modified and extended with such a functionality.

The ONOS project provides a tutorial [76] describing preparation of Mininet-based packet optical emulation environment, along with rudimentary Mininet patches. Open vSwitch is used to emulate L3 switches, whereas LINC switch for Optical Emulation (LINC-OE) [86] is used to

emulate ROADM and Hybrid switches (with vendor extensions as defined by the Optical Transport Working Group in ONF). All artifacts are open source and available to use.

Julius emulation environment [77], based on Mininet, aims to provide multi-layer, fixed and flex-grid optical networks emulation capabilities. It consists of the orchestration layer, which implements the application logic for the creation and management of the emulation environment and includes Traffic Engineering Database (TED) and the Label Switched Path Database (LSP-DB). Mininet is responsible for topology creation. Open vSwitch is used to emulate L3 switches, whereas LINC-OE is used to emulate ROADM and Hybrid switches. Julius interacts with them using OpenFlow 1.3 with proprietary Infoblox Optical Extensions. LINC switch also supports OpenFlow 1.4 and OF-Config. The LINC switch project seems to be abandoned, as it have not received any commits since 2015. Julius also consists of execution layer, which uses Mantis PCE [87]. These layers are completed by the access layer with a web interface, which allows to graphically define topologies and traffic demands and provides real-time view of current network status, including established lightpaths and link utilization details. Julius is not openly available.

SONEP is another multi-layer emulation environment [78]. Although it is not directly based on Mininet, it uses the same Linux kernel lightweight virtualization mechanism — network namespaces and virtual Ethernet links. Each veth pair plays the role of an individual WDM channel. Veth pairs are bridged with Ethernet bridges (brct1) and controlled by TC/Netem (tc). SONEP authors used Stanford reference implementation of OpenFlow userspace switch as a base and extended it with the support for emulated WDM channels. Such a virtual Open Transport

Table 7: Multi-layer SDN emulators summary.

Emulator	Technology	Switches	Available	Notes
Mininet	Linux netns and veth	Open vSwitch (L3) None (optical)	Yes	Does not support multi-layer, must be extended
ONOS Packet Optical	Linux netns and veth	Open vSwitch (L3) LINC-OE (optical)	Yes	Based on Mininet
Julius	Linux netns and veth	Open vSwitch (L3) LINC-OE (optical)	No	Based on Mininet
SONEP	Linux netns and veth	Open vSwitch (L3) Custom (optical)	No	
Netphony GMPLS emulator	Java	Custom (L3) Custom (optical)	Yes	Does not allow running custom applications

Switch (OTS) is controlled by the OpenFlow protocol, which also was extended with custom messages. Neither SONEP nor any of its customized components code is publicly available.

Telefonica I+D published a repository [79] containing the code of Java based Emulator of a Transport Node (L1/L0) with GMPLS control plane (OSPF-TE, RSVP-TE, PCEP). The project, however, seems to be abandoned and lacks even basic usage documentation.

The summary of presented multi-layer SDN emulators is provided in Table 7.

6.4. Testbeds

Emulators provide a quick way to evaluate networking mechanisms. They have a great flexibility, allowing to run networks with arbitrary topologies. It, however, comes at the cost of low performance. Emulators do not use hardware switches, so they cannot be used for performance evaluations and do not emulate hardware limitations, bugs and other peculiarities.

Network testbeds use real hardware, so they can be used for performance evaluation of the proposed algorithms. Such an ability comes with the expense of flexibility: it is possible to run a limited set of topologies in any particular testbed. Testbeds are also more expensive than emulation platforms.

Small testbeds are often constructed in house, in order to evaluate specific systems. Large scale testbeds, due to their costs, are being built by consortia or research agencies and shared amongst multiple projects. They can be used by researchers belonging to a particular consortium or country. Some of them are available for researchers from all over the world.

Therefore, we present in this section only large-scale testbeds which both:

- are available for public use,
- provide multi-layer/optical SDN capabilities, or have a record of such experiments.

GENI (Global Environment for Network Innovations) [80] is a US-based testbed, sponsored by the National Science Foundation (NSF). It is available for US and Brazil scientists, who need to become project members in order to use it. GENI is a federated testbed. Different organizations host GENI resources and make them available

to GENI experimenters. GENI network links are sliced by Ethernet VLANs i.e. multiple experiments sharing the same physical link are given different VLANs on that link. Slicing by VLAN guarantees traffic isolation among experiments. Slicing tools used in GENI include: FlowVisor, OpenVirteX, and FlowSpace Firewall. Programmability in GENI is achieved by OpenFlow switches. There are two papers, which describe optical SDN experiments in GENI [88] [89]. GENI provides only OpenFlow-based control plane without any associated optical hardware in the data plane. So in both experiments, optical topology was emulated using the control plane.

ESNet (Energy Sciences Network) [81] provides two network testbeds for the community. These testbeds are available to academic and industry researches. Unlike GENI, ESNet testbeds access is not limited to US-based researchers. The 100G SDN testbed consists of a dedicated 100G wave and a 10G overlay on the production network that includes Denver, Washington DC, New York, Atlanta, Amsterdam, and Geneva. There are several devices that support SDN experiments, and several hosts, including hosts with 40G and 100G NICs. In 2012, Infinera company tested a prototype of Open Transport Switch (OTS) allowing ESnet's optical transport network to be configured by an SDN controller via the OpenFlow protocol with custom extensions [90]. The demo used On-Demand Secure Circuits and the Advanced Reservation System (OSCARS) controller, which is a provisioning system developed by ESNet. It provides centralized traffic-engineering capabilities with multi-domain scheduling and reservation. The demo was extended in a traffic optimization mechanisms research, presented in [91].

RISE (Research Infrastructure for Large-Scale Experiments) [82] [92] is a Japan-based SDN/OpenFlow testbed, which allows users to conduct experiments and verifications on a wide SDN environment. RISE is administered by the National Institute of Information and Communications Technology of Japan (NICT). It is open to the researchers. RISE consists of OpenFlow switches and uses EoMPLS to provide virtual topology slices. It also incorporates optical and circuit integrated network (OPCI) [93].

Many papers study cooperation of OPCI networks with OpenFlow networks: [94] [95] [96]. There is also a press release [97] describing experimental demonstration of SDN/

OpenFlow control of a nationwide network that mutually connects transport networks constructed at seven locations in Japan and the United States, what is further elaborated in the article [98].

OFELIA was a European Union Seventh Framework Programme (FP7) research project, which goal was to construct flexible OpenFlow-based network testbed. There are papers describing OpenFlow-GMPLS integration in OFELIA and optical network virtualization attempts. OFELIA testbed, however, ceased its operation when the project ended, so we do not describe it in detail. The website of the project, which hosted documentation and results, is no longer available.

The summary of presented multi-layer SDN testbeds is provided in Table 8.

Table 8: Multi-layer SDN testbeds summary.

Testbed	Optical topology	Sponsor	Availability
GENI	emulated	NSF (US)	US- and Brazil-based researchers
ESNet	real	DoE (US)	World
RISE	real	NICT (Japan)	World
OFELIA	real	7FP (EU)	None (ceased operation)

7. Inter/intra-DC SDN

A multi-layer SDN concept in the context of inter and intra datacenter (DC) networking is mostly considered as integration between cloud and network infrastructures. Simultaneously, most of the works consider solely packet networks without mentioning the optical layer. Those papers are therefore out of the scope of this survey. Our aim is to address multi-layer networks utilized in inter and intra DC scenarios.

As presented in the summarizing Table 10 numerous taxonomies are applicable in the context of Inter/intra-DC SDN. We decided to divide this section with respect to the perspective from which those infrastructures are considered (as shown in Figure 19). Therefore consecutive subsections refer to the carrier, mobile network, and service provider perspectives.

7.1. Carrier perspective

In [99] SDN was deployed in Wide Area Network (WAN) multi-layer network and additionally conjuncted with the cloud orchestration software. The novelty of the solution lies mostly in the carrier-based approach which is in opposition to the most common application-oriented solutions. The main advantage is a possibility to optimize multi-layer network utilization in the environment with multiple customers, in this case denoted as cloud operators. A valuable testbed has been built comprising hardware and management layers. Multi-layer WAN architecture was improved in terms of effective communication between distributed data centers.

The general principle is to distinguish two types of communication in WAN. The first one, is a communication between enterprise customers and data centers owned by the Cloud Service Providers (CSP). This type of traffic can be described as small dynamic packet flows handled mostly in the electrical layer. On the other hand, communication between data centers comprises much larger and less bursty flows of more predictable nature. Optical networks are the most suitable to handle this type of communication. The most important contribution of the paper is twofold. First of all, the authors proposed a mechanism to assign consecutive requests to the proper layer as presented in Table 9. Secondly, SDN is considered as a solution able to optimize both network layers simultaneously. Namely, IP layer traffic is optimized in the way to enable efficient handling of more demanding

requests in optical layers. Integration between a cloud orchestrator and an SDN controller is ensured via open API which abstracts underlying infrastructures. The proposed integration enables additional opportunities to predict, optimize and manage more critical requests between data centers. For example, cloud orchestration software may request to increase bandwidth of a flow assigned to particular inter-DC communication. As a result the existing flow will remain active in the network for a shorter time. This concept is denoted in the paper as Bandwidth on Demand (BoD) and utilized REST JSON notation to deploy two simple, but efficient, message types: create and delete. Results provided in the paper were collected in the testbed and are divided into two categories. The first one considers general capabilities of the proposed solution in terms of traffic routing and rerouting. The second one refers to more sophisticated scenarios. For example, load-balancing between virtual machines was investigated with respect to the time efficiency and rate of successfully established TCP connections. Conducted experiments proved that proposed solution is able to dynamically adjust resources to handle incoming requests.

Table 9: VLAN rate to network layer mapping [99].

VLAN rate	Network layer
Low-rate	IP/MPLS Layer
High-rate	Optical Transport Layer
Highest rate	ROADM Layer

In another work considering the carrier perspective [100] authors proposed an SDN-based architecture in which core transport optical network interconnecting data centers is abstracted as a programmable virtual switch denoted as OTS. The solution respects the fact, that SDN is also deployed in fully electrical data center networks and packet/optical transition is performed between inter and intra-DC networks. Thus, a single protocol and architecture can be utilized to control both intra-DC networks and WAN interconnecting them. The aim of the work is to present possible advantages enabled by applying SDN in the multi-layer network interconnecting data centers. Thanks to the programmability and flexibility of SDN several complex issues may be addressed, e.g. multi-vendor, multi-layer, and multi-domain problems. Valuable testbed was implemented and utilized to conduct a research. In metropolitan area test network OTS was deployed to handle big-

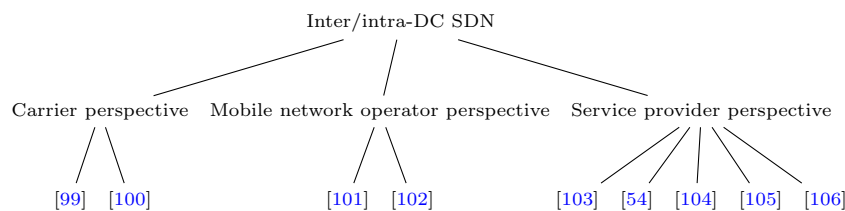

Figure 19: Structure of the Section 7.

data application traffic. Delay in path establishment was measured and compared with reference scenarios. It was shown that significant improvements can be obtained in WAN utilization by introducing SDN in such a multi-layer and multi-domain architecture. Advantages are considered in comparison to the static solutions where optical trunks are established in a long term manner and most of the network functions are placed in the network layer of OSI/ISO model. Such an approach cannot adjust to changing network requirements. In addition to the novel solution authors proposed also two approaches to integrate OTS architecture with existing networks and, in this way, migrate towards more flexible and efficient solution.

7.2. Mobile network operator perspective

Inter-DC SDNs have been also considered in the context of mobile operators and 5G networks in [101]. The concept is further extended in journal paper [102]. Authors assumed distributed cloud/fog infrastructure of 5G networks and assume that requirements applicable to 5G networks impose the need for SDN and NFV concepts to deploy an integrated end-to-end resource provisioning system. Integrated SDN/NFV orchestrator can dynamically and effectively provision network resources in Mobile Networks. Improvements are achieved by the creation of isolated virtual backhaul for multiple tenants in the multi-layer aggregation network and deployment of virtual network functions in data centers connected with those networks. Thanks to the resources provisioned in common physical infrastructure, mobile network operators are able to connect their radio access networks (RAN) without upfront investments in the cloud and network infrastructure. Each tenant receives dedicated virtualized control plane denoted as virtualized SDN (vSDN) controller deployed in the cloud. In addition to the multi-layer mobile virtual network provisioning two other use cases were considered: (1) orchestration of full stack IoT services utilizing fog resources, and (2) hierarchical SDN-based control plane to jointly orchestrate wireless and optical network. A demonstrator was deployed in order to validate the solution.

Multi-layer aspect in both papers is significant, but simultaneously, slightly simplified. Four separate controllers orchestrate packet domain connected to the tenants RAN, packet network connected to the data center, intra-DC network, and optical network domain. Packet network controllers request optical network controller to establish optical paths and ensure connectivity between packet domains connecting RANs and data centers. A detailed architecture of each domain was carefully studied in the papers. We mostly focus on aggregation network where multi-layer manner is strongly visible. This part of the infrastructure utilizes traffic grooming techniques, multiplexing available in the electric layer, and huge capacities provided by the optical layer. Optical connectivity between data centers and RAN is abstracted from the vSDN point of view. Namely, each packet domain is represented by a single

packet switch node. Multi-layer infrastructure is configured by the dedicated entity denoted as multi-layer SDN orchestrator (MSO) which aim is to interconnect all of the packet domains and provision resources to create virtual backhauls for particular tenants. Once resources are provisioned vSDN receives proper notification and tenant is able to control its virtualized infrastructure. Performance measurements were made in the deployed demonstrator. Establishment of connectivity between packet domains takes around 11 ms, while complete backhaul infrastructure is fully operative in less than 80 ms. Relatively short times result from the fact that optical transceivers are pre-configured.

7.3. Service provider perspective

All the remaining works represent service provider perspective approach to the Inter/intra-DC SDN networks. In the first work [103] extraordinary assumption regarding the knowledge about network topology was taken. Namely, the authors demonstrated multi-domain software-defined transport networking (SDTN), but in their approach the global topology information is not presented. It is motivated by the fact that multi-controller environment excludes availability of such information. Three schemas for data center interconnection were considered: a controller-driven scheme (ConDS), a cloud-driven scheme (CIDS), and a CIDS with dynamic optimization (CIDS-DO).

SDN enables network and cloud operators to handle requests by dynamic services provision and assigning resources in a way to minimize both operating and capital expenditures. Additional contribution comprises an extension of the OpenFlow protocol and the API interface to ensure the communication between cloud and network providers. Multi-layer aspects are considered from the multi-domain point of view. Namely, a wide area SDTN is assumed to be fully optical while interconnected data center networks are packet-based. Therefore, the multi-layer architecture is strongly combined with multi-domain issues.

The main aim of the [103] is to design multi-controller environment in a way to satisfy requirements of both network and data center operators. Domain term regards to both data centers and segments of optical transport network. The problem is denoted as end-to-end, i.e. traversing multiple domains under the control of different controllers, service provisioning under quality of service prerequisites. Another important aim is to create such a multi-controller infrastructure in a way to provide all the features available in single controller environments. For this purpose, the data center orchestration layer was incorporated into the well-known 3-layer SDN architecture. It allows to abstract both multi-layer network and data center resources in inter-controller communication as illustrated in Figure 20.

The integration is further complicated by the presence of NFV deploying network functions on general purpose hardware. To ensure control of optical nodes OpenFlow

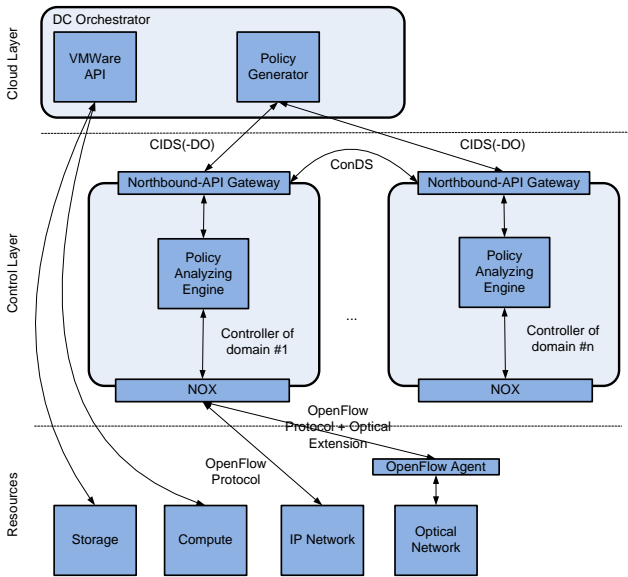

Figure 20: Multi-controller architecture handling multi-layer infrastructure [103].

agents were deployed on each device to translate vendor-specific commands into well-known OpenFlow messages.

A significant part of the work is a demonstrator comprising hardware network devices, virtualized computing infrastructure and virtual network functions. A set of engineering tools was used for the purpose of demonstrator implementation and valuable conclusions about related lessons learned are provided. Similarly to previous works virtual machine migration service was investigated. Applied performance indicators compare proposed schemas in terms of signaling latency, migration speed and blocking probability.

Contrary to previous works authors in [54] consider the IP over Flexi-Grid optical network as an architecture most suitable to ensure connectivity between geographically distributed data centers. The most important advantages of this architecture are: efficient resource utilization and flexibility in terms of handling various bandwidth demands. Simultaneously, the IP over Flexi-Grid optical network is expected to be cost-effective, highly-available, and energy-efficient. The main contribution of the paper is service-aware mechanism to ensure resilience in multi-layer SDN network interconnecting data centers offering cloud services. The specific feature of the proposed solution is the utilization of multiple network layers during the restoration process. Different simulation scenarios were studied in two network topologies with variable failure rates. Measured and analyzed performance indicators are path blocking probability, time needed to restore the path, and resource utilization. Provided results show significant advantages of the algorithm proposed in the paper.

Three layers were considered during service recovery:

(1) IP resources, (2) Flexi-Grid optical resources, and (3) data center application resources (computing and storage). Software-based control plane is defined for each of the layers in a unified way as presented in the Figure 21. Controllers in each layer have a modular form to ensure maximum performance and scalability. An extension of OpenFlow protocol has been utilized to control optical nodes and IP routers with OpenFlow agents installed. The cooperation between network layers is crucial to ensure cloud services provisioning resilience against network node failures. Optical node outage is detected by the optical network controller. The impact on the service provisioning resilience is immediately analyzed by the IP layer controller previously informed about an event. Then, as a result, a new optical path is provisioned and proper configuration changes are applied in the data center infrastructure. For the purpose of inter-controller communication, the authors propose a novel protocol utilizing UDP.

Contrary to all other works considered in this Section, paper [104] regards to the purely intra-DC networks. Authors stated that advanced applications and services like Virtual Machine Migration (VMM), MapReduce, or many other impose demanding requirements on networks inside data centers. It further increases CAPEX and OPEX mainly due to the fact that building fully bisectional network architectures imposes linear increase of the number of switches in function of the number of servers. To overcome this disadvantage the authors proposed a novel architecture for multi-layer intra-DC network. It comprises low-cost distributed optical switches and SDN-based control plane as presented in Figure 22. An application-aware approach enables establishing different communication types between data center top of the rack switches. Control plane dynamically and flexibly decides whether to establish all-optical, hybrid or electrical end-to-end communication.

A multi-layer nature of the proposed architecture is revealed in the increasing network capacity with growing demands. The authors assume that in the basic state, all electrical fat tree topology is present in the data center. In case when additional capacity is needed a reference approach would be to add more electrical switches. Instead doing that, the authors proposed to install pluggable small-scale optical switches (e.g. MEMS-based) to selected ports of electrical switches. Locations for placing those additional optical devices are selected based on the distribution of traffic in the network. Such a solution is scalable as increasing capacity needs results in adding optical switches. Therefore, in addition to the fat-tree electrical network, supplementary fat-tree all optical network is built but with reduced number of nodes. Pluggable optical transceiver modules serves as points where traffic may traverse between layers. The SDN controller handles both electrical switches and small-scale optical nodes. Additional entity computes routing policies and communicates them with the controller. Routing decisions are made for each request based on its expected bandwidth,

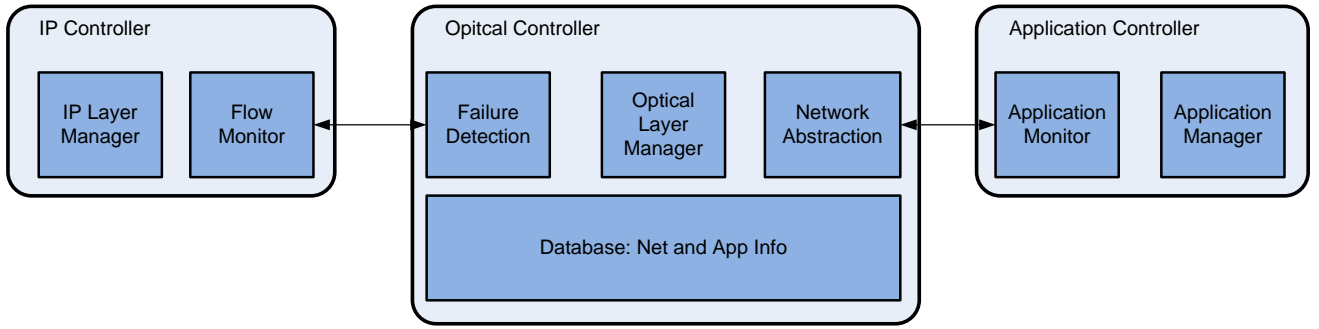

Figure 21: Software defined control plane in multi-layer architecture [54].

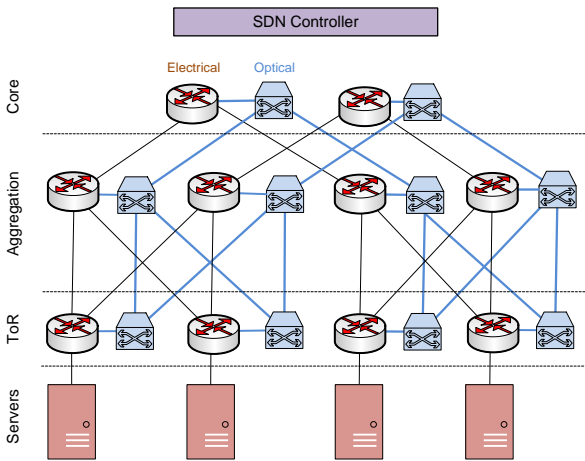

Figure 22: Hybrid intra-DC architecture comprising low cost optical switches [104].

duration and delay requirements. As a result, a particular request may be handled in either pure electrical or optical layer resources. It is also possible to handle a request via the hybrid path traversing both layers. Research was conducted in interesting experimental multi-layer testbed setup carefully described in the paper. For the purpose of experiments real-time traffic was injected to the network and the SDN control plane was working in fully automatic manner. Improvements has been observed in comparison to all-electrical reference scenario with respect to the delay and resilience capabilities.

Two complementing papers were published by the same authors during a single conference: [105] and [106]. Inter-DC and intra-DC networks are studied simultaneously assuming that inter-DC network has a multi-layer, IP over flexi-grid (as in [54]), infrastructure. On the other hand, intra-DC network is assumed to be fully optical. Furthermore, data center computing and storage resources are considered as an integrated part of the whole infras-

tructure. Efficient resource provisioning in such an environment is the main aim of those works. To achieve that, the authors proposed the SDN-based control plane abstracting all resources in an unified manner. It regards not only to packet and optical network but also data center resources. Authors expected to utilize advantages of optical networks combined with SDN-based solution to provide highly efficient, tunable and dynamic resource provisioning framework. Especially flexi-grid underlaying transport network is indicated as the most suitable to meet requirements imposed by the nature of cloud-related traffic. To validate proposed solution, a demonstrator was built.

A significant and valuable contribution of both papers is, firstly, technically precise description of architectures of both inter and intra data center networks. Also, a novel time-aware software defined networking (TASDN) architecture proposed as a solution for intra-DC infrastructures must be mentioned. Finally, for inter-DC networks architecture called enhanced SDN (eSDN) was proposed. The OpenFlow protocol was extended by additional features to implement both proposals in the testbed. The most important assumptions and principles are as follows. Separate SDN controllers were developed to handle different types of resources (packer, optical, and data center) which is in line with the approach presented in [103]. Furthermore, OpenFlow agents are installed on flexi-grid optical devices to ensure communication with the controller. Due to the application-aware nature of the proposed solution a dedicated application plane provides cloud services through the specified interface. Thus, the authors designed a fully multi-layer solution where cloud services are provisioned based on the properties of routing paths. Those paths are further dependent on physical layer parameters specific for flexi-grid optical network (e.g. optical channel bandwidth or modulation format). Numerical results presented in the paper were collected in the demonstrator and are separately presented for intra and inter-DC networks.

Lightpath provisioning in the TASDN architecture was validated under intra-DC cloud service migration scenario. The results proved that proposed time-aware approach is

Table 10: Summary of approaches to SDN-based multi-layer inter/intra-DC networks.

Reference	Scope	Integration with orchestrator	Multidomain architecture	Inter-controller communication	Virtualization considered	Testbed	Optical layer
Doverspike et. al. [99]	Inter-DC	Yes	Carrier	Yes	No	Yes	DWDM
Sadasivarao et. al. [100]	Inter-DC	No	Carrier	Yes	No	Yes	DWDM
Vilatala et. al. [101] and Martinez et. al. [102]	Inter-DC	Yes	Mobile	No	Yes	Yes	Not specified
Yu et. al. [103]	Inter-DC	Yes	Service	No	Yes	Yes	(D)WDM
Yang et. al. [54]	Inter-DC	Yes	Service	No	No	No	Flex-grid
Kanonakis et. al. [104]	Intra-DC	No	Service	Yes	No	Yes	MEMS
Zhao et. al. [105] [106]	Inter-DC Intra-DC	Yes	Service	Yes	No	Yes	Flex-grid

especially useful for congested networks and provides improvements in terms of blocking probability and resource utilization. Then, a service migration procedure was also considered in the eSDN architecture designed for inter-DC networks. The authors focused on the time needed to setup and release resources, as well as, timing capabilities between control plane components. Finally, improvements in terms of blocking probability and resource utilization were observed for the whole infrastructure comprising both intra and inter DC networks, as well as, cloud resources.

In the Table 10 presented approaches to SDN-based multi-layer inter/intra-DC networks are summarized. One of the advantages of works regarding the multi-layer inter/intra-DC networks is fact that most of them use testbed environments to validate proposed solutions. Secondly, the issue of integration with cloud orchestrator is well addressed from different perspectives and in different contexts. However, several shortcomings also should be mentioned. For example, the aspect of virtualization is considered only in three works and none of them addresses carrier perspective. It should be improved, especially in the context of Network Function Virtualization concept. Second potential area of research covers inter-controller communication issues in mobile multi-domain architecture.

8. Remaining relevant topics

This section consists of topics relevant to multi-layer SDN networks in general but not assigned to any other section. Thus, the overview of SDN-based monitoring approaches is presented. Efficient and real-time monitoring must be ensured in the network to enable dynamic QoS solutions. Furthermore, the selected aspects of access control and security, along with some issues related to multi-domain multi-layer networks are covered. The taxonomy of references is presented in Figure 23.

8.1. Multi-layer SDN monitoring

Efficient, accurate and real-time are key goals for frameworks willing to apply QoS-aware solutions in SDN networks. It is impossible to effectively route traffic and optimize resource provisioning in service-aware manner without having the knowledge about network resource utilization, latency, potential misconfigurations and other disruptions.

First group of monitoring solutions refers to the disaggregation concept which originates from servers environment where it was denoted as breaking infrastructure of a single computer into a set of individual resources, e.g. memory, CPU, cache, networking, etc. It was also defined as decoupling underlying hardware from software (operating system) working on top of it. What is, de facto, standard in server architectures is now being adopted to the network devices. Different hardware components should be able to cooperate as a single device and any network operating system should be able to run on top of this abstract entity. There should be no difference if those components are commercial products or open source projects. Disaggregation is gaining more and more attention as it is fully in line with the NFV concept. As disaggregated software components may realize different network functions in various network layers, it is reasonable to consider disaggregated multi-layer node in the SDN network. SDN-based monitoring and data analytics architecture for multi-layer disaggregated nodes was proposed in [107] and further extended in [108]. Dedicated solution is needed due to the complexity of disaggregated nodes and increasing importance of network automation based on precise monitoring and telemetry. Node's architecture considered in [108]

comprises three elements: MPLS-TP switch, transponder node, and optical switch. Authors proposed seven elements to be monitored by the framework: (1) electronic layer switch interfaces (L2-SI), (2) aggregated traffic in the electronic layer (L2-NI), (3) uplink (L0-SI) and (4) downlink interface (L0-CI) between layers, (5) WDM interfaces of optical switch (L0-NI), (6) layer two LSP traffic (L2-LSP), and finally, (7) optical layer LSP (L0-LSP) parameters (BER and optical power). This simple architecture presented in Figure 24 is just an example and, by analogy, can be further extended to other layers.

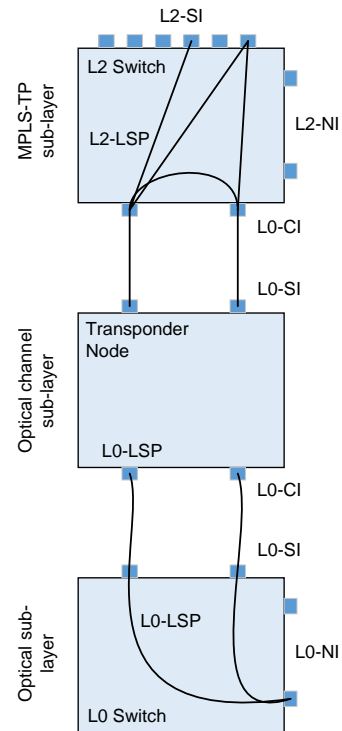

Figure 24: Monitored elements in the disaggregated architecture [108].

The original architecture considered in papers [107] and [108] is denoted as monitoring and data analytics (MDA) and comprises two main components. First one is central-

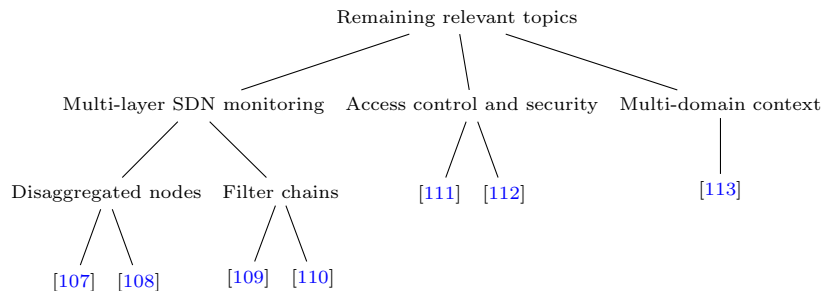

Figure 23: Structure of the Section 8.

ized data storage entity able to perform data analytics, the second one are dedicated generic monitoring/telemetry agents distributed among multi-layer disaggregated nodes. Agents collect and aggregate data in aforementioned observation points in network nodes. Preprocessed data is then passed to the centralized system which extracts knowledge from data and notifies the SDN controller about potential disruptions in network operations. The controller synchronizes databases operating at different network layers, e.g. physical topology and LSP. Another feature of the proposed architecture is the coexistence of two Observe-Analyze-Act (OAA) control loops. First one is triggered by the local agent and changes configuration of a single node (e.g. modulation format). The second control loop is network wide and is triggered by configuration changes introduced by the local loop (e.g. change in modulation format may enable grooming more traffic in this particular optical channel).

Three different and valuable use cases were presented in [108]. However, one of them is especially interesting from the viewpoint of multi-layer SDN networks. The use case is triggered once bit error rate degradation is detected by a local agent. As a result, modulation format is changed by the local OAA mechanism and a notification is sent to the SDN controller. The controller's responsibility is to change the capacity in two network layers: the optical channel and the MPLS-TP path. Thanks to this actions both operational databases remain synchronized and up to date. The proposed architecture was experimentally validated based on the multi-stage network operation analysis. Authors focused on the messages being exchanged between components during selected system activities. For example, synchronization of architecture elements or creation and self-configuration of paths at different network layers. Also self-healing procedure was deeply analyzed as a more complex scenario. Therefore, authors proved that the integration of the SDN controller with the MDA system brings advantages in multi-layer self-operating networks. The SDN part allows for programmability and network re-configuration while MDS enables advanced data analytics mechanisms on monitoring data. Distribution of responsibilities between node-dedicated agents and centralized entity improves scalability, and simultaneously, reduces the amount of signaling data being exchanged as well as latency in anomaly detection.

An approach based on the analytics and measurements is also presented in [109] and further extended in [110]. The authors aimed at optimizing network resource utilization without deterioration the quality of transmission (QoT) in multi-layer and multi-technology scenarios. A centralized control layer of SDN is indicated as an ideal entity to collect monitoring data from optical and electronic layers to perform globally-scoped optimization. As a result, optical layer can be reconfigured or even redesigned in order to counteract changes occurring at any layer of the network infrastructure. Similarly to previous works, the authors suggested what kind of information should

be collected from measurements in optical layer. Examples are as follows: OSNR monitoring, ubiquitous power monitoring, BER estimation, chromatic dispersion, polarization mode dispersion, and fiber nonlinearity. Several network scenarios (denoted in the papers as applications or functions) were considered. For example, network-wide OSNR analysis make it possible to replan network before potential disruptions may occur. Simultaneously, real-time monitoring can trigger immediate network reconfigurations to counteract congestions. The proposed framework may also be useful to diagnose failures and identify reasons originating from different layers. Finally, one of the fundamental functions provided by the framework is an abstraction of multi-layer network.

The OpenDaylight (ODL) controller was utilized in the proposed framework. The system has modular structure and comprises components having different responsibilities. Namely, data analytics component, users' gateway handling external requests, monitoring collector gathering data from ODL and optical domain probes, and finally, configuration manager applying changes through the network controller. The architecture is presented in the Figure 25. The Open Flow protocol was extended to support optical nodes what further enables configuration of optical cross-connects or add-drop multiplexers in a vendor agnostic manner. The principle of operation lies in the filter chains concept. Each entry in such a filter defines technology (either optical or packet), parameter to be filtered (e.g. power or rate), threshold type (e.g. min, max, etc.) and value, ports to which chain should be applied, and finally, actions to be performed once the threshold is crossed. Those filters are configurable, periodically triggered with assumed period, and applied to monitoring data retrieved from the network.

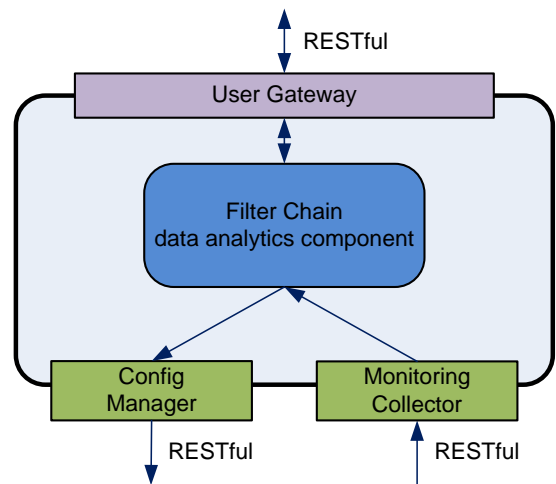

Figure 25: Architecture of the solution proposed in [110].

Experimental demonstrations were conducted in both [109] as well as [110] papers. Authors showed features and capabilities of their framework analyzing real life use cases. First use case is especially important from the viewpoint of multi-layer network. It regards to the network node responsible for the conversion of Ethernet client's traffic into the optical signal. The aim is to ensure high spectral efficiency of the output signal based on the analytical considerations performed by the framework. Monitoring data collected from both network layers is then applied to optimize resource utilization and ensure QoS. It is possible thanks to the fact that measured data enables replanning of optical network to handle increasing OSNR in selected network regions. The second use case utilizes measurements of ubiquitous power in order to optimize synthesis of different optical signals at couplers and multiplexers. The aim is to reduce signal degradation during this process. Finally, in the last use case, the proposed framework is applied to identify failed network components and propose the restoration process in the optical layer. To sum up, the provided results confirm that monitoring both layers of multi-layer SDN network enables central controller to optimize resource utilization, ensures desired quality of service and improves infrastructure reliability.

Practical value of analytics and automation platforms can be observed in the portfolio of Packet Design company. They offer SDN Analytics and Automation Platform⁵. Vendor-agnostic and time efficient monitoring and analysis of network resources across multiple network layers and domains are the main advantages of the platform.

8.2. Access control and security

In [111], a new system is presented. The system is based on the SDN concept, however, the analyzed layers are control plane and application layer. The key issue is to protect network against malicious attacks from the application layer. The authors indicate that compromised SDN controllers may result in changing network operations or cloud applications' instructions.

The proposed multi-layer access control system restricts the number of instructions a telco cloud component is allowed to perform. The proposed system is presented in Figure 26.

The key element of the system is cloud management, which is a descriptor that allows to define application-specific policies. The SDN controller is extended by a Policy Enforcement (PE) unit, a modified northbound interface, a SDN specific interface for controller extensions and a corresponding service which provides this interface. CSCF is a Call Session Control Function and PCRF is a Policy and Charging Rules Function cloud application. PCRF decides in real-time which traffic can be accepted

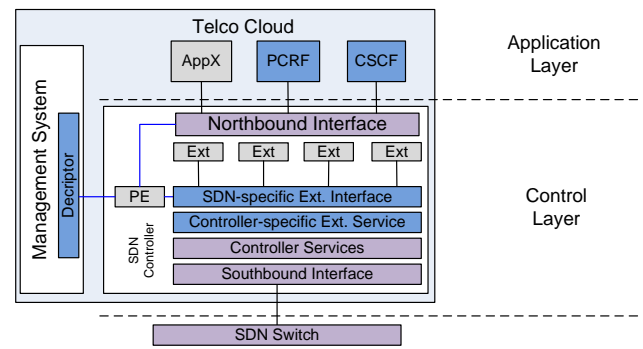

Figure 26: Access system control [111].

or not based on the predefined parameters. The SDN controller is responsible to react properly to configuration instructions set from the independent management system. The SDN controller translates such high-level instructions received on the northbound interface into forwarding rules which are finally added to Forwarding Tables (FT) in an SDN switch. In the proposed system it is possible to restrict the set of critical operations. Thus, it is possible for example to control the load balancer in such a way that it is only able to read a certain part of the topology or to write only forwarding rules containing IP destination addresses of one of the backend servers. As a result, in such a network, an attacker cannot view or re-program the entire network anymore.

Another solution to the security problem of multi-layer SDN networks is presented in [112], where the extended ACINO orchestrator is proposed. The authors of the paper present an architecture for an automatic secure service in a multi-layer (IP, Ethernet and optical) network. In the system, the appropriate encryption layer using an open-source SDN orchestrator is implemented. The main ACINO orchestrator architecture is presented in Figure 27.

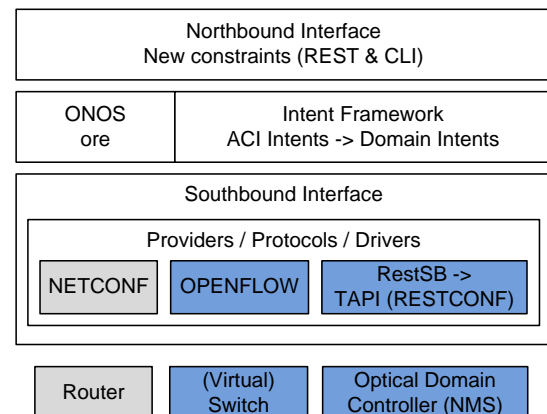

Figure 27: ACINO orchestrator architecture [112].

⁵<https://www.packetdesign.com/products/sdn-analytics-and-automation-platform/>

Table 11: Comparison of security approaches in SDN networks.

	Jager et. al. [111]	Szyrkowicz et. al. [112]
Approach	Malicious attacks	Encryption
Key problem	Malicious attacks from application layer	Encryption of transmission for requests from nodes
Proposed solution	Cloud management system	ACINO orchestrators
Proposed method	Definition of application-specific policies	Encryption for every request

The extensions to the ACINO orchestrators presented in the paper assume the definition of new primitives that allow the extended intent compiler to make a decision regarding the right layer of encryption for every request. Moreover, it is necessary to install the resulting secure service using new functionality in the drivers, including protocol extensions in the compiler. More specifically, the extended ACINO orchestrator defines a lightweight north-bound interface to specify application needs through intents. The encryption concept is related and depends on the intended needs.

In the paper, the results of evaluation experiments conducted in a testbed with commercial equipment are presented. It has been shown that the processing impact of secure channel creation on a controller and other security features is negligible.

The summarized comparison of the described approaches is presented in Table 11. As one can see, two security-related issues have been analyzed. The first one is related to malicious attacks, and the second one describes encryption. The undesirable results of attacks from the application layer can be minimized by implementing the cloud management system. On the other hand, the ACINO orchestrators can ensure encryption of transmission for requests from nodes. In both cases, it is necessary to implement the proper policy to ensure the adequate level of security.

8.3. Multi-domain multi-layer networks

Networks evolve into a complex multidomain multi-layer architectures, where traffic engineering across multiple domains and layers poses challenges for the control plane, especially when operators do not wish to disclose their network topology and resource information.

In [113], the authors develop an architecture to enable traffic engineering in multi-layer networks spanning through multiple domains (controlled by different operators) in such a way, that the operators do not need to disclose their internal network structure and other information.

Figure 28 shows the proposed architecture. Due to multi-domain and multi-layer setup, a hierarchical architecture for control plane is proposed. The unique idea here is to introduce a Root Controller (RC) at the top layer. RC manages the entire network. Sub-networks are controlled by layer-1 controllers (L1C), and sub-sub-networks are controlled by layer-2 controllers (L2C). Every controller at a higher layer coordinates the lower-layer

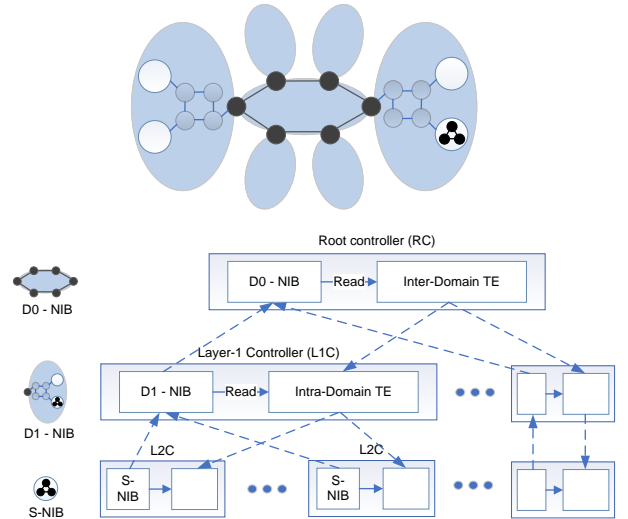

Figure 28: The hierarchical controller architecture [113].

controllers inside the local domain (e.g. RC coordinates all L1Cs). The main coordination task for RC is routing the cross-L1C traffic. An L1C, on the other hand, manages the routing of traffic inside its local domain, where it sees L2C as separate entities.

For each domain, network topology and other critical information such as e.g. QoS-related data, are aggregated into a hierarchical Network Information Base (NIB) for confidentiality reasons. The NIB represents aggregated network-wide state including internal topology and information on all ongoing flows. Therefore, local controllers do not need to disclose their network topologies — they appear as an abstraction in other controller’s NIB.

The heart of the proposal is a communication protocol, which allows controllers at different layers and domains to work collaboratively on bandwidth allocation by reading other NIBs. For the proposal to be complete, the authors present an improved Google’s B4 traffic engineering algorithm [114] which considers bandwidth and delay constraints at the same time to meet user’s requirement.

9. Open challenges and future research directions

The section consists of two subsections. The [subsection 9.1](#) provides the information related to deployment stage of multi-layer solutions described in the previous chapters. This information is also presented in [Table 12](#) in a concise form. In turn, the [subsection 9.2](#) describes the open challenges and future research directions related to multi-layer SDN approach.

9.1. Comparison of multi-layer SDN solutions

The mechanisms proposed in [24], [25], [26], [28],[29] were investigating simulation tools. In papers [24], [25], [26], [38], the application-aware framework was implemented in the Net2Plan, whereas [27] described only the concept of this framework. The presented solution will be released as the part of SDN orchestrator. In [39], SDN architecture for Packet Optical networks was demonstrated. The platform was based on available commercial equipments. In paper [40], the proposed AHB mechanism was implemented in the ns-3 simulator.

The concept of Pseudo-wire multi-layer networks and path computation therein, as presented in [41], was shown as a mathematical model. The authors did not perform any simulations and did not create a testbed. The concept of [46] was tested through simulations. The simulation environment was developed by the authors in C++. The QNOX mechanism [45] was developed and tested in prototype implementation. The implementation was based on modified Linux router.

In [48] the proposed network model was verified by simulation and have been demonstrated by an implemented prototype. In [49], the proposed Survivable Automatic Hidden Bypass mechanism was implemented in the ns-3 simulator. At this stage, further work is considered, but still on the simulator/virtual demo level. The multi-layer restoration plan presented in [50] was analyzed by the demo set in Telefonica's + D/GCTO lab. As it confirmed the advantages of the proposed solution (54% lower traffic loss), it has a real chance for further development and implementation.

In [54], [55] and [56] the performance of resilience against node failures was evaluated in a simulation environment. Additionally, experimental verification of this solution is provided in [55].

The proposal presented in [51] was tested in a lab based on German carrier network. This typical lab testbed confirms the assumptions. However, the conclusion on the possibility of implementation in real networks will be available after the implementation of a prototype and its evaluation in a networking testbed. Such a testbed has been considered by the authors as the next step of their research work.

The proposed solution analyzed in [52] was evaluated in a simulation environment and experimentally implemented in an SDN-based testbed. The same authors extended their work to the Segment Routing Failover scheme

under assumption of node failure in multi-domain multi-layer SDN networks, which was analyzed in [53]. While the authors provided some testbeds and continue their work, the further extensions of their work are possible.

The mechanisms proposed and described in [57] are currently only at the theoretical analysis stage. On the other hand, the concept of cognitive fault management presented in [58] has been tested in lab using hardware. While the authors used the machine learning implementation, their proposal will probably gain attention from the industry. Machine learning is gaining momentum in optical networking industry and solutions based on this approach are more than welcome in networking. The mechanism proposed in [59] probably will not be further extended and implemented. This is a result of fact that FAN has never been implemented in real networks. Also in [60] the only simulation results have been presented. Currently, it is impossible to predict the future of the proposed solution to support reliability for power grid applications.

The results shown in [71] and [72] have been obtained in the lab. The authors built a demo based on different vendors equipment. While the results are still at the early-stage level, there is a real chance of it to be used in the future in large telecommunication operators networks. The orchestrator presented in [73] has been implemented in a demo based on the ADVA equipment. As the results are optimistic, further works on this proposal may result in implementation in networks. The orchestrator presented in [74] has been implemented and developed in the PRONet network, which is a two-layer Research and Education Network (REN). It has been deployed at and around the UT Dallas campus. While the results show the advantages of the proposed orchestrator, it is possible to offer it for wider deployment and use. The authors have proposed the architecture, which is implemented and available as the Open Source Netphony suite. It enables multi-layer network programmability. The testbed analysis conducted by researchers from Telefonica confirmed that the proposed framework works as it was assumed. The suit is publicly available and ready to use.

Solutions regarding monitoring in the SDN networks have reached very advanced development stage, as all of the conceptual proposals were validated in the physical testbed. Similar conclusions can be drawn for the proposed SDN controllers. Namely, all of the controllers have been validated against compliance with physical devices. However, only solutions originating from academia ([71], [72], [73], [74], [75]) are considered at conceptual level. Most of the solutions addressing inter/intra-DC issues have been validated in the physical testbed scenario. It demonstrates the maturity of the SDN concept in all of the mentioned areas. Only work [54] was assessed in simulator environment instead of testbed.

At the same time, solutions proposed in [99] and [103] were thoroughly validated not only in physical, but also virtual testbeds. On the other hand, absolutely opposite conclusions are drawn when considering solutions in the

Table 12: Deployment stage of multi-layer SDN solutions.

Topic	Paper	Deployment stage			
		Concept	Simulation	Virtual testbed	Physical testbed
Resource allocation	[24] [25] [26]	x	x		
	[27]	x			
	[28]	x	x		
	[29]	x	x		
QoS-aware path provisioning	[38] [26] [25]	x	x		
	[39]	x			x
	[40]	x	x		
	[41]	x			
	[46]	x			
	[45]	x		x	
Resilience	[48]	x	x		x
	[49]	x	x		
	[50]	x			x
	[54] [55] [56]	x	x		[55]
	[51]	x			x
	[52] [53]	x	x		x
	[57]	x			
	[58]	x			x
	[59]	x	x		
	[60]	x	x		
Inter/intra-DC SDN	[99]	x		x	x
	[100]	x			x
	[101]	x			x
	[102]	x			x
	[103]	x		x	x
	[54]	x	x		
	[104]	x			x
	[105]	x			x
[106]	x			x	
SDN monitoring	[107]	x			x
	[108]	x			x
	[109]	x			x
	[110]	x			x
SDN controllers	[69]				x
	Sedona				x
	Coriant				x
	[70]				x
	[71]	x			x
	[72]	x			x
	[73]	x			x
[74]	x			x	
[75]	x			x	
Green networking	[30]	x	x		
	[31]	x	x		
	[32]	x	x		
	[33]	x		x	

area of green networking. All of the solutions are presented at the conceptual level but none of them was validated in a physical testbed. Only [33] was assessed in the virtual testbed while three remaining works ([30], [31], [32]) were investigated utilizing simulation tools.

9.2. Future research directions

This section describes the open challenges and future research directions related to multi-layer approach.

9.2.1. Multi-layer SDN controllers

The most important issue directly associated with multi-layer SDN controllers regards to the lack of standardization of Southbound-API interface between network controller and optical network devices. There is an initial proposition to utilize OpenFlow+ protocol, however, it is a common approach that each producer uses their own vendor-specific protocols. Furthermore, in case of multi-layer networks we can expect that separate controllers will handle different layers of the infrastructure. To coordinate operations performed on such a infrastructure controller-

to-controller communication protocols should be defined and standardized. As suggested in [103] the problem may be complicated even further as network operators willing to cooperate may be unwilling to explicitly share information about their infrastructures. Thus, proper abstraction should be provided for such operators.

Multi-layer networks very often impose multi-layer control plane architectures. In this case, northbound-APIs of SDN controllers are utilized, and thus, the lack of standardization also in this aspect opens an interesting future challenges. Not only proposals of a protocol for this interface are expected but also scientific considerations may be conducted for example in terms of trade-off between configurability and easy of use.

Another important open issue regards to the expected security mechanisms. It is especially crucial in multi-layer SDN networks where numerous SDN controllers responsible for different resources need to communicate through the secure channel. Furthermore, for some critical applications it is required to ensure that data path provisioned in a multi-layer network by an SDN controller is secure, and for example, traverses only eligible network nodes. Moreover, inter-controller transmission needs additional attention regarding security and protection. All security and encryption issues related to SDN should also apply for multi-layer solutions.

9.2.2. Orchestrators

Implementation of orchestrators will probably be necessary for future complex SDN multi-layer networks. They play an important role for controllers operations organization. The effectiveness of their work will influence the whole operation of the SDN-based multi-layer networks. The orchestrators are additional network element, which usually is not present in single-controller. Therefore, orchestrators should be proposed and developed taking into consideration all aspects which influence stability of controller operation.

9.2.3. Emulators

Mininet is a widely-popular, proven, and de facto standard SDN emulator. It does not, however, provide multi-layer or optical network emulation capabilities. Patches provided by the ONOS project are very rudimentary. Emulation environments presented in Julius and SONEP papers seems to be more advanced, but are not publicly available.

Therefore, there is a need for a similar proven emulator for multi-layers networks. It can be based on Mininet, extended with management of virtual WDM/DWDM channels and optical resources. The lack of such an emulator may be a result of absence of virtual optical switch software, as LINC-OE project was abandoned. Implementation of a virtual optical switch software is probably being hindered by the lack of standardized Southbound-API between switches and controllers.

9.2.4. Green networking

Most of the energy consumption models of multi-layer network devices comprise two factors. The first one is constant in time and reflects the energy needed to power on the device. The second one is proportional to the current utilization of the device. However, several concerns are rising when SDN is considered in this context. First of all, research was conducted to investigate if multi-layer network nodes follow the proportional computing paradigm and if SDN capabilities can further improve it. Moreover, multi-layer nodes have complex architectures that can be further complicated by the disaggregation concept, were parts of those nodes can be individually managed by the centralized control entity. Therefore, further studies are needed how such disaggregated SDN-based architectures impact assumed energy consumption models. Finally, thanks to the dynamic capabilities of SDN new research areas are opening. Namely, switching capacity in both IP and optical layers may be forced to follow the availability of green and cheap energy in wide area networks.

Another possible research area is even more fundamental. As summarized in the Table 2 all of the solutions are focused on energy consumption of particular network layer. It means that there is a lack of energy consumption model which will comprise both packet and optical layers and will be considered in the SDN environment. Formal statement of such a model provided in companion of the algorithms able to effectively solve it, will be an important development in the field of multi-layer and SDN-based green networking.

9.2.5. Inter/intra-DC SDN

Inter and intra DC networking is strongly associated with numerous services, applications, and modern networking solutions. For example, 5G mobile networks host virtualized components in data centers, IoT applications connect send to the clouds enormous amount of data, or simply, services provided to individual customers impose huge traffic to and between DCs. Therefore, there is a strong need to integrate end-to-end service provisioning with network control and management. Inter/intra-DC multi-layer SDN networks should cooperate with service orchestrators to follow the nature of modern traffic patterns and ensure dynamic network reconfiguration. The issue is even more important and complicated when considering integration between cloud and fog infrastructures through the SDN multi-layer networks [101]. According to the considerations presented in [99] such an integration of SDN control plane and functions orchestration is also needed to provision reliability. Sophisticated models of potential outage scenarios are expected to include cost, performance and latency considerations.

Integrated orchestration of SDN network and NFV infrastructure running in the data center is considered in [102]. The whole work is based on the assumption that multiple mobile network operators are connected to the SDN multi-layer access infrastructure enabling dynamic

and automatic network slicing. Thus, researchers should propose algorithms and proof of concepts that can meet requirements imposed by multi-tenant 5G infrastructure. Examples of the most emerging open issues to be addressed are as follows:

- how SDN can be adopted to the heterogeneous infrastructure where multi-layer and multi-domain perspectives overlap each other;
- applicability of SDN to 5G network slices comprising not only multi-layer networks but also computing resources available in the centralized data centers, distributed edges and mobile fogs;
- can SDN help meeting application-aware requirements defined in 5G standards as enhanced Mobile Broadband, Ultra Reliable Low Latency Communications and massive Machine Type Communications.

9.2.6. Dynamic QoS-aware path and flow provisioning

The notion of QoS currently exists in almost all network architectures. SDN is no exception. For example, the authors of path computation in multi-layer multi-domain networks [43] want to figure out the whole problem of end-to-end service delivery. They plan to extend their solution to support end-to-end Quality of Service constraints and model all technology constraints on the different layers, through protocol conversion or mapping. As a future work, they also plan to investigate which part of their algorithms can be distributed and how such a solution can be established on current networks.

Another interesting issue is the provisioning of multipath transmissions. For safety purposes, most current transmissions is realized via one single path, even though it is technically possible to route traffic via several paths. The realization is, however, challenging and it becomes even more difficult in multi-layer environment. In [46], the authors investigated the Multipath TCP protocol for provisioning QoS in multi-layer networks. Such and similar approaches are likely to appear in the future.

9.2.7. Monitoring

Interesting future research challenges are presented in the context of secure services provisioned in multi-layer SDN and proposed in [83]. However, those future directions are more universal and can be easily generalized. First of all, there is a need for monitoring applications able to provide performance metrics, alarms and error counters for SDN-based multi-layer networks. Such a solution will be an enabler for automation in control and management process. For example, real time utilization metrics of both optical and electrical layers make it possible to dynamically route incoming traffic in order to avoid any congestions.

As stated in [110] in order to take advantage of multi-layer network programmability detailed information about optical layer physical parameters need to be collected by

monitoring systems. For example, link transmission performance, power information, link impairment, and pre-forward error correct (pre-FEC) bit error rate (BER). Currently, there is no standard for data structure enabling exchange of such information. Furthermore, most of the production-ready network analytics are still limited to the packet level while hardware based parameters, extremely important in case of multi-layer optical networks, are neglected. Without comprehensive research in those areas cross-stratum optimization cannot be developed in production environments.

Authors in [115] indicated that also multi-layer SDN networks management is decoupled at the IP and optical layers separately. Thus, operation, administration, and maintenance processes should be redefined to utilize capabilities of SDN in the context of multi-layer networks.

9.2.8. Resilience

Global knowledge and programmability of SDN-based control plane creates an opportunity to implement resilience and recovery mechanisms. In terms of multi-layer networks further research challenges regard mainly to the mixed failure scenarios in which resources in both layers are affected. It is also an interesting issue to counteract failures in a particular layer utilizing resources available in other layers. Similar conclusions are drawn regarding the mechanisms proposed in [54].

Resiliency is a complicated problem. Future works will develop hybrid multi-layer resiliency solutions dedicated for SDN. Since the restoration path usually has a different physical length and a number of hops compared to the working path, the consideration of physical layer impairments, modulation formats or even bandwidth restoration is an important open issue.

9.2.9. Resource allocation

To meet the traffic growth, traffic shifts and network failures, realistic application demands should be analyzed. Because of the fact that only the ACINO project considers application requirements, it is still an important issue. Future works will focus on direct mapping of the specific application requirements onto the multi-layer networks. On the another hand, utilizing multipath routing as well as periodical re-optimization of the IP routes may help reduce the power consumption of the network without causing service interruptions. Also, the SDN concept gives the opportunity that network capacity can be adjusted in dynamic and integrated multi-layer manners. Efficient use of multi-layer network resources can be achieved based on traffic prediction and forecasting. Summarized future works are presented in [116].

10. Conclusions

Combining network traffic control of many layers at the same time can provide benefits. The concept of SDN can be used to efficiently manage and control the whole network in all its layers. As the surveyed solutions show, applying SDN to multiple layers provides new possibilities.

In this survey, we presented, compared and contrasted solutions that utilize SDN in multi-layer network architectures. The main objective was to analyze multi-layer network architectures and show how these solutions coupled with SDN contribute to make future networks simple, flexible and cost-effective. This survey fills the gap between the SDN concept and its possible implementations. There is a plethora of applications for a multi-layer SDN architecture. Although their adaptation and implementation may be difficult, we believe that the future of networking is bound with being software-oriented.

The key point of this survey is to present the newest proposals for multi-layer SDNs. However, we do not only present such solution, but also analyze their impact on network stability and complexity. The aspects of resource allocation, security and resilience and network element provisioning are key elements when planning the network architecture. Moreover, the analysis of controllers, orchestrators, emulators and testbeds provides additional information which is crucial for network optimization. The presented aspects were also analyzed for both, inter and intra-DC SDNs. Finally, we present the issues, which will play the crucial role in future multi-layer SDNs.

Acknowledgment

The research was carried out with the support of the project "Intelligent management of traffic in multi-layer Software-Defined Networks" founded by the Polish National Science Centre under project no. 2017/25/B/ST6/02186.

References

- [1] M. Jarschel, T. Zimmer, T. Hossfeld, P. Tran-Gia, W. Kellerer, Interfaces, attributes, and use cases: A compass for SDN, *IEEE Communications Magazine* 52 (6) (2014) 210–217. doi:10.1109/MCOM.2014.6829966.
- [2] N. Feamster, J. Rexford, E. Zegura, The Road to SDN: An Intellectual History of Programmable Networks, *SIGCOMM Comput. Commun. Rev.* 44 (2) (2014) 87–98. doi:10.1145/2602204.2602219.
- [3] S. Sun, L. Gong, B. Rong, K. Lu, An intelligent SDN framework for 5G heterogeneous networks, *IEEE Communications Magazine* 53 (11) (2015) 142–147. doi:10.1109/MCOM.2015.7321983.
- [4] H. C. Yu, G. Quer, R. R. Rao, Wireless SDN mobile ad hoc network: From theory to practice, in: 2017 IEEE International Conference on Communications (ICC), 2017, pp. 1–7. doi:10.1109/ICC.2017.7996340.
- [5] Y. Sinha, S. Bhatia, V. S. Shekhawat, G. S. S. Chalapathi, MPLS based hybridization in SDN, in: 2017 Fourth International Conference on Software Defined Systems (SDS), 2017, pp. 156–161. doi:10.1109/SDS.2017.7939157.
- [6] K. Kalkan, S. Zeadally, Securing Internet of Things with Software Defined Networking, *IEEE Communications Magazine* 56 (9) (2018) 186–192. doi:10.1109/MCOM.2017.1700714.
- [7] O. Flauzac, C. González, A. Hachani, F. Nolot, SDN Based Architecture for IoT and Improvement of the Security, in: 2015 IEEE 29th International Conference on Advanced Information Networking and Applications Workshops, 2015, pp. 688–693. doi:10.1109/WAINA.2015.110.
- [8] M. B. Yassein, S. Aljawarneh, M. Al-Rousan, W. Mardini, W. Al-Rashdan, Combined software-defined network (SDN) and Internet of Things (IoT), in: 2017 International Conference on Electrical and Computing Technologies and Applications (ICECTA), 2017, pp. 1–6. doi:10.1109/ICECTA.2017.8252003.
- [9] I. Ku, Y. Lu, M. Gerla, R. L. Gomes, F. Ongaro, E. Cerqueira, Towards software-defined VANET: Architecture and services, in: 2014 13th Annual Mediterranean Ad Hoc Networking Workshop (MED-HOC-NET), 2014, pp. 103–110. doi:10.1109/MedHocNet.2014.6849111.
- [10] S. Indriyanto, M. N. D. Satria, A. R. Sulaeman, R. Hakimi, E. Mulyana, Performance analysis of VANET simulation on software defined network, in: 2017 3rd International Conference on Wireless and Telematics (ICWT), 2017, pp. 81–85. doi:10.1109/ICWT.2017.8284143.
- [11] A. Gharaibeh, M. A. Salahuddin, S. J. Hussini, A. Khreishah, I. Khalil, M. Guizani, A. Al-Fuqaha, Smart Cities: A Survey on Data Management, Security, and Enabling Technologies, *IEEE Communications Surveys Tutorials* 19 (4) (2017) 2456–2501. doi:10.1109/COMST.2017.2736886.
- [12] Y. Bi, C. Lin, H. Zhou, P. Yang, X. Shen, H. Zhao, Time-Constrained Big Data Transfer for SDN-Enabled Smart City, *IEEE Communications Magazine* 55 (12) (2017) 44–50. doi:10.1109/MCOM.2017.1700236.
- [13] M. Karakus, A. Durresi, Quality of service (qos) in software defined networking (sdn): A survey, *Journal of Network and Computer Applications* 80 (2017) 200 – 218. doi:https://doi.org/10.1016/j.jnca.2016.12.019.
- [14] A. S. Thyagaturu, A. Mercian, M. P. McGarry, M. Reisslein, W. Kellerer, Software Defined Optical Networks (SDONs): A Comprehensive Survey, *IEEE Communications Surveys Tutorials* 18 (4) (2016) 2738–2786. doi:10.1109/COMST.2016.2586999.
- [15] M. Kivelä, A. Arenas, M. Barthelemy, J. Gleeson, Y. Moreno, M. Porter, Multi-layer networks, *Journal of Complex Networks* 2 (3) (2014) 203–271. doi:10.1093/comnet/cnu016.
- [16] Y. Yoshida, A. Maruta, K.-i. Kitayama, M. Nishihara, T. Tanaka, T. Takahara, J. C. Rasmussen, N. Yoshikane, T. Tsuritani, I. Morita, et al., SDN-Based Network Orchestration of Variable-Capacity Optical Packet Switching Network Over Programmable Flexi-Grid Elastic Optical Path Network, *Journal of Lightwave Technology* 33 (3) (2015) 609–617. doi:10.1109/JLT.2014.2351852.
- [17] T. Lehman, X. Yang, N. Ghani, F. Gu, C. Guok, I. Monga, B. Tierney, Multilayer networks: an architecture framework, *IEEE Communications Magazine* 49 (5) (2011) 122–130. doi:10.1109/MCOM.2011.5762808.
- [18] M. Ruiz, O. Pedrola, L. Velasco, D. Careglio, J. Fernández-Palacios, G. Junyent, Survivable IP/MPLS-Over-WSO Multilayer Network Optimization, *IEEE/OSA Journal of Optical Communications and Networking* 3 (8) (2011) 629–640. doi:10.1364/JOCN.3.000629.
- [19] Y. Iizawa, K. Suzuki, Multi-layer and multi-domain network orchestration by odenos, in: 2016 Optical Fiber Communications Conference and Exhibition (OFC), 2016, pp. 1–3. doi:10.1364/OFC.2016.Th1A.3.
- [20] R. Muñoz, A. Mayoral, R. Vilalta, R. Casellas, R. Martínez, V. López, The need for a transport API in 5G networks: The control orchestration protocol, in: 2016 Optical Fiber Communications Conference and Exhibition (OFC), 2016, pp. 1–3. doi:10.1364/OFC.2016.Th3K.4.
- [21] P. J. Argibay-losada, Y. Yoshida, A. Maruta, K. Kitayama,

- Optical versus electronic packet switching in delay-sensitive 5G networks: myths versus advantages, *IEEE/OSA Journal of Optical Communications and Networking* 8 (11) (2016) B43–B54. doi:10.1364/JOCN.8.000B43.
- [22] T. Tojo, S. Okada, Y. Hirata, S. Yasukawa, Multi-layer SDN control technology, *NTT Technical Review* 16 (8) (2018) 62–67.
- [23] A. Autenrieth, T. Szyrkowicz, K. Grobe, J. Elbers, P. Kaczmarek, P. Kostecki, W. Kellerer, Evaluation of virtualization models for optical connectivity service providers, in: 2014 International Conference on Optical Network Design and Modeling, 2014, pp. 264–268.
- [24] M. Savi, F. Pederzoli, D. Siracusa, An application-aware multi-layer service provisioning algorithm based on auxiliary graphs, *Opt. InfoBase Conf. Pap. Part F40-O* (2014) 3–5. doi:10.1364/OFC.2017.W3I.2.
- [25] M. Savi, C. Rozic, C. Matrakidis, D. Klionidis, D. Siracusa, I. Tomkos, Benefits of multi-layer application-aware resource allocation and optimization, in: 2017 European Conference on Networks and Communications (EuCNC), 2017, pp. 1–5. doi:10.1109/EuCNC.2017.7980661.
- [26] Ćiril Rozić, M. Savi, C. Matrakidis, D. Klionidis, D. Siracusa, I. Tomkos, A framework for dynamic multi-layer resource allocation and optimization in application-centric networking, in: 2017 Optical Fiber Communications Conference and Exhibition (OFC), 2017, pp. 1–3.
- [27] P. Sköldström, C. Rozić, J. Pedreno-Manresa, Making powerful friends: Introducing ONOS and Net2Plan to each other, in: 2017 19th International Conference on Transparent Optical Networks (ICTON), 2017, pp. 1–4. doi:10.1109/ICTON.2017.8025040.
- [28] J. Zhang, Y. Ji, M. Song, H. Li, R. Gu, Y. Zhao, J. Zhang, Dynamic Virtual Network Embedding Over Multilayer Optical Networks, *IEEE/OSA Journal of Optical Communications and Networking* 7 (9) (2015) 918–927. doi:10.1364/JOCN.7.000918.
- [29] E. Biernacka, J. Domzał, R. Wójcik, Dynamic sliceable optical bypasses in SDN-based networks, in: 2017 19th International Conference on Transparent Optical Networks (ICTON), 2017, pp. 1–4. doi:10.1109/ICTON.2017.8024962.
- [30] J. Rzaśa, P. Boryło, A. Lason, A. Szymanski, A. Jajszczyk, Dynamic power capping for multilayer hybrid power networks, in: 2014 IEEE Global Communications Conference, 2014, pp. 2516–2522. doi:10.1109/GLOCOM.2014.7037186.
- [31] J. Rzaśa, P. Boryło, A. Lason, A. Szymanski, A. Jajszczyk, Assessment of a power capping strategy in a multilayer network with a variable number of green nodes, in: 2016 21st European Conference on Networks and Optical Communications (NOC), 2016, pp. 183–190. doi:10.1109/NOC.2016.7507010.
- [32] H. Khodakarami, B. S. G. Pillai, W. Shieh, Quality of service provisioning and energy minimized scheduling in software defined flexible optical networks, *IEEE/OSA Journal of Optical Communications and Networking* 8 (2) (2016) 118–128. doi:10.1364/JOCN.8.000118.
- [33] Y. Xiong, J. Shi, Y. Yang, Y. Lv, G. N. Rouskas, Light-path Management in SDN-Based Elastic Optical Networks With Power Consumption Considerations, *Journal of Lightwave Technology* 36 (9) (2018) 1650–1660. doi:10.1109/JLT.2017.2785410.
- [34] U. Zehra, M. A. Shah, A survey on resource allocation in software defined networks (SDN), in: 2017 23rd International Conference on Automation and Computing (ICAC), 2017, pp. 1–6. doi:10.23919/ICAC.2017.8082092.
- [35] S. K. Tayyaba, M. A. Shah, Resource allocation in SDN based 5G cellular networks, *Peer-to-Peer Networking and Applications* 12 (2) (2019) 514–538. doi:10.1007/s12083-018-0651-3.
- [36] S. Kang, W. Yoon, Sdn-based resource allocation for heterogeneous lte and wlan multi-radio networks, *The Journal of Supercomputing* 72 (4) (2016) 1342–1362. doi:10.1007/s11227-016-1662-6.
- [37] Y. Zhang, L. Cui, W. Wang, Y. Zhang, A survey on software defined networking with multiple controllers, *Journal of Network and Computer Applications* 103 (2018) 101 – 118. doi:10.1016/j.jnca.2017.11.015.
- [38] C. Rozic, D. Klionidis, I. Tomkos, Latency-aware Multi-layer Network Optimization in IP-over-WDM Core Networks, in: ECOC 2016; 42nd European Conference on Optical Communication, 2016, pp. 1–3.
- [39] A. Felix, N. Borges, H. Wu, M. Hanlon, M. Birk, A. Tschersich, Multi-layer SDN on a commercial network control platform for packet optical networks, in: OFC 2014, 2014, pp. 1–3. doi:10.1364/OFC.2014.Th5A.1.
- [40] J. Domzał, Z. Duliński, J. Rzaśa, P. Gawłowicz, E. Biernacka, R. Wójcik, Automatic Hidden Bypasses in Software-Defined Networks, *J. Netw. Syst. Manag.* (2016) 1–24doi:10.1007/s10922-016-9397-5.
- [41] M. L. Lamali, H. Pouyllau, D. Barth, Path computation in multi-layer multi-domain networks: A language theoretic approach, *Computer Communications* 36 (5) (2013) 589–599. doi:10.1016/j.comcom.2012.11.009.
- [42] P. Pate, S. Bryant, Pseudo Wire Emulation Edge-to-Edge (PWE3) Architecture, RFC 3985 (Mar. 2005). doi:10.17487/RFC3985. URL <https://rfc-editor.org/rfc/rfc3985.txt>
- [43] M. L. Lamali, N. Fergani, J. Cohen, H. Pouyllau, Path computation in multi-layer networks: Complexity and algorithms, *CoRR abs/1601.01786* (2016). arXiv:1601.01786. URL <http://arxiv.org/abs/1601.01786>
- [44] S. Tariq, M. Bassiouni, Performance evaluation of MPTCP over optical burst switching in data centers, in: 2014 International Telecommunications Symposium (ITS), 2014, pp. 1–5. doi:10.1109/ITS.2014.6948036.
- [45] K. Jeong, J. Kim, Y. T. Kim, QoS-aware Network Operating System for software defined networking with Generalized OpenFlows, in: 2012 IEEE Network Operations and Management Symposium, 2012, pp. 1167–1174. doi:10.1109/NOMS.2012.6212044.
- [46] S. Tariq, M. Bassiouni, QAMO-SDN: QoS aware Multipath TCP for software defined optical networks, in: 2015 12th Annual IEEE Consumer Communications and Networking Conference (CCNC), 2015, pp. 485–491. doi:10.1109/CCNC.2015.7158023.
- [47] N. Gude, T. Koponen, J. Pettit, B. Pfaff, M. Casado, N. McKeown, S. Shenker, NOX: Towards an Operating System for Networks, *SIGCOMM Comput. Commun. Rev.* 38 (3) (2008) 105–110. doi:10.1145/1384609.1384625.
- [48] D. Zhang, X. Song, C. Chen, H. Guo, J. Wu, Y. Xia, Software defined synergistic IP+optical resilient transport networks [Invited], *IEEE/OSA Journal of Optical Communications and Networking* 7 (2) (2015) A209–A217. doi:10.1364/JOCN.7.00A209.
- [49] P. Boryło, J. Domzał, R. Wójcik, Survivable automatic hidden bypasses in Software-Defined Networks, *Comput. Networks* 133 (2018) 73–89. doi:10.1016/j.comnet.2018.01.022.
- [50] I. Maor, O. Gerstel, V. Lopez, T. Szyrkowicz, A. Autenrieth, B. Pruessing, N. Borges, F. Fu, G. Fabregas, J. P. Fernandez-Palacios, First demonstration of SDN-controlled Multi-Layer Restoration and its advantage over Optical Restoration, in: ECOC 2016; 42nd European Conference on Optical Communication, 2016, pp. 1–3.
- [51] J. Blendin, D. Herrmann, M. Wichtlhuber, M. Gunkel, F. Wisel, D. Hausheer, Enabling efficient multi-layer repair in elastic optical networks by gradually superimposing SDN, in: 12th International Conference on Network and Service Management (CNSM), Montreal, Canada, 2016, pp. 118–126. doi:10.1109/CNSM.2016.7818407.
- [52] A. Giorgetti, A. Sgambelluri, F. Paolucci, F. Cugini, P. Castoldi, Demonstration of dynamic restoration in segment routing multi-layer SDN networks, in: 2016 Optical Fiber Communications Conference and Exhibition (OFC), 2016, pp. 1–3.
- [53] A. Giorgetti, A. Sgambelluri, F. Paolucci, F. Cugini, P. Cas-

- toldi, Segment routing for effective recovery and multi-domain traffic engineering, *IEEE/OSA Journal of Optical Communications and Networking* 9 (2) (2017) A223–A232. doi:[10.1364/JOCN.9.00A223](https://doi.org/10.1364/JOCN.9.00A223).
- [54] H. Yang, J. Zhang, Y. Zhao, L. Cheng, J. Wu, Y. Ji, J. Han, Y. Lin, Y. Lee, Service-aware resources integrated resilience for software defined data center networking based on ip over flexi-grid optical networks, *Optical Fiber Technology* 21 (2015) 93 – 102. doi:<https://doi.org/10.1016/j.yofte.2014.09.002>.
- [55] H. Yang, Y. Zhao, J. Zhang, L. Cheng, Y. Ji, J. Wu, J. Han, Y. Lin, Y. Lee, Multi-stratum resources resilience in software defined data center interconnection based on IP over elastic optical networks, *Photonic Netw. Commun.* 28 (1) (2014) 58–70. doi:[10.1007/s11107-014-0440-8](https://doi.org/10.1007/s11107-014-0440-8).
- [56] H. Yang, Y. Zhao, J. Zhang, L. Cheng, Y. Ji, J. Wu, J. Han, Y. Lin, Y. Lee, Global Resources Integrated Resilience for Software Defined Data Center Interconnection Based on IP Over Elastic Optical Network, *IEEE Commun. Lett.* 18 (10) (2014). doi:[10.1109/LCOMM.2014.2353633](https://doi.org/10.1109/LCOMM.2014.2353633).
- [57] V. Lopez, J. P. F. Palacios, T. Szyrkowicz, M. Chamania, Multi-layer resilience schemes and their control plane support, in: *DRCN 2017 - Design of Reliable Communication Networks*, Munich, Germany, 2017, pp. 1–7.
- [58] D. Rafique, T. Szyrkowicz, H. Grießer, A. Autenrieth, J.-P. Elbers, Cognitive Assurance Architecture for Optical Network Fault Management, *Journal of Lightwave Technology* 36 (2018) 1443–1450. doi:[10.1109/JLT.2017.2781540](https://doi.org/10.1109/JLT.2017.2781540).
- [59] J. Domżał, R. Wójcik, E. Biernacka, Efficient and reliable transmission in flow-aware networks — an integrated approach based on sdn concept, in: *2017 International Conference on Computing, Networking and Communications (ICNC)*, 2017, pp. 837–842. doi:[10.1109/ICCNC.2017.7876240](https://doi.org/10.1109/ICCNC.2017.7876240).
- [60] H. Rastegarfar, D. C. Kilper, Robust Software-Defined Optical Networking for the Power Grid, in: *Proc. International Conference on Computing, Networking and Communications (ICNC)*, Kauai, HI, USA, 2016, pp. 1–5. doi:[10.1109/ICCNC.2016.7440552](https://doi.org/10.1109/ICCNC.2016.7440552).
- [61] P. Smith, A. Schaeffer-Filho, D. Hutchison, A. Mauthe, Management patterns: SDN-enabled network resilience management, in: *2014 IEEE Network Operations and Management Symposium (NOMS)*, 2014, pp. 1–9. doi:[10.1109/NOMS.2014.6838323](https://doi.org/10.1109/NOMS.2014.6838323).
- [62] K. Benzekki, A. El Fergougui, A. Elbelrhiti Elalaoui, Software-defined networking (SDN): a survey, *Security and Communication Networks* 9 (18) (2016) 5803–5833. doi:[10.1002/sec.1737](https://doi.org/10.1002/sec.1737).
- [63] D. Kreutz, F. M. V. Ramos, P. E. Verissimo, C. E. Rothenberg, S. Azodolmolky, S. Uhlig, Software-Defined Networking: A Comprehensive Survey, *Proceedings of the IEEE* 103 (1) (2015) 14–76. doi:[10.1109/JPROC.2014.2371999](https://doi.org/10.1109/JPROC.2014.2371999).
- [64] P. C. d. R. Fonseca, E. S. Mota, A Survey on Fault Management in Software-Defined Networks, *IEEE Communications Surveys Tutorials* 19 (4) (2017) 2284–2321. doi:[10.1109/COMST.2017.2719862](https://doi.org/10.1109/COMST.2017.2719862).
- [65] Y. Yu, X. Li, X. Leng, L. Song, K. Bu, Y. Chen, J. Yang, L. Zhang, K. Cheng, X. Xiao, Fault Management in Software-Defined Networking: A Survey, *IEEE Communications Surveys Tutorials* 21 (1) (2019) 349–392. doi:[10.1109/COMST.2018.2868922](https://doi.org/10.1109/COMST.2018.2868922).
- [66] Y. Zhang, N. Beheshti, M. Tatipamula, On Resilience of Split-Architecture Networks, in: *2011 IEEE Global Telecommunications Conference - GLOBECOM 2011*, 2011, pp. 1–6. doi:[10.1109/GLOCOM.2011.6134496](https://doi.org/10.1109/GLOCOM.2011.6134496).
- [67] Y. Hu, W. Wendong, X. Gong, X. Que, C. Shiduan, Reliability-aware controller placement for Software-Defined Networks, in: *2013 IFIP/IEEE International Symposium on Integrated Network Management (IM 2013)*, 2013, pp. 672–675.
- [68] M. Guo, P. Bhattacharya, Controller Placement for Improving Resilience of Software-Defined Networks, in: *2013 Fourth International Conference on Networking and Distributed Computing*, 2013, pp. 23–27. doi:[10.1109/ICND.2013.15](https://doi.org/10.1109/ICND.2013.15).
- [69] J. Networks, *NorthStar Controller—Multilayer SDN Coordination and Optimization* (2015). URL <https://static.ziftsolutions.com/files/8a0f761c53f8aca201541640309817a0>
- [70] O. Project, Multi-layer Network Control with ONOS, http://onosproject.org/wp-content/uploads/2015/06/PoC_multilayer.pdf (2015).
- [71] O. Gerstel, V. Lopez, The need for sdn in orchestration of ip over optical multi-vendor networks, in: *2015 European Conference on Optical Communication (ECOC)*, 2015, pp. 1–3. doi:[10.1109/ECOC.2015.7341833](https://doi.org/10.1109/ECOC.2015.7341833).
- [72] O. Gerstel, V. Lopez, D. Siracusa, Multi-layer orchestration for application-centric networking, in: *2015 International Conference on Photonics in Switching (PS)*, 2015, pp. 318–320. doi:[10.1109/PS.2015.7329039](https://doi.org/10.1109/PS.2015.7329039).
- [73] R. Martínez, A. Mayoral, R. Vilalta, R. Casellas, R. Muñoz, S. Pachnicke, T. Szyrkowicz, A. Autenrieth, Integrated SDN/NFV orchestration for the dynamic deployment of mobile virtual backhaul networks over a multi-layer (Packet/Optical) aggregation infrastructure, in: *2016 Optical Fiber Communications Conference and Exhibition (OFC)*, 2016, pp. 1–3. doi:[10.1364/OFC.2016.Th1A.1](https://doi.org/10.1364/OFC.2016.Th1A.1).
- [74] B. Mirkhanzadeh, C. Shao, M. Razo, M. Tacca, A. Fumagalli, G. M. Galimberti, G. Martinelli, M. Cardani, Demonstration of an SDN orchestrator for both flow provisioning and fault handling in an Ethernet-over-WDM Network, in: *2017 19th International Conference on Transparent Optical Networks (ICTON)*, 2017, pp. 1–4. doi:[10.1109/ICTON.2017.8024936](https://doi.org/10.1109/ICTON.2017.8024936).
- [75] V. López, R. Jimenez, O. G. de Dios, L. M. Contreras, J. P. F. Palacios, Open Source Netphony suite: Enabling multi-layer network programmability, in: *2017 International Conference on Optical Network Design and Modeling (ONDM)*, 2017, pp. 1–6. doi:[10.23919/ONDM.2017.7958538](https://doi.org/10.23919/ONDM.2017.7958538).
- [76] *The Packet Optical Dev Environment - ONOS*. URL <https://wiki.onosproject.org/display/ONOS/The+Packet+Optical+Dev+Environment>
- [77] A. Kretsis, L. Corazza, K. Christodoulopoulos, P. Kokkinos, E. Varvarigos, An emulation environment for SDN enabled flexible IP/optical networks, in: *Transparent Optical Networks (ICTON)*, 2016 18th International Conference on, IEEE, 2016, pp. 1–4. doi:[10.1109/ICTON.2016.7550422](https://doi.org/10.1109/ICTON.2016.7550422).
- [78] S. Azodolmolky, M. N. Petersen, A. M. Fagertun, P. Wieder, S. R. Ruepp, R. Yahyapour, SONEP: A software-defined optical network emulation platform, in: *Optical Network Design and Modeling*, 2014 International Conference on, IEEE, 2014, pp. 216–221.
- [79] *netphony-gmpls-emulator*. URL <https://github.com/telefonicaid/netphony-gmpls-emulator>
- [80] M. Berman, J. S. Chase, L. Landweber, A. Nakao, M. Ott, D. Raychaudhuri, R. Ricci, I. Seskar, GENI: A federated testbed for innovative network experiments, *Computer Networks* 61 (2014) 5 – 23, special issue on Future Internet Testbeds – Part I. doi:[10.1016/j.bjp.2013.12.037](https://doi.org/10.1016/j.bjp.2013.12.037).
- [81] *100G SDN Testbed*. URL <http://es.net/network-r-and-d/experimental-network-testbeds/100g-sdn-testbed/>
- [82] *RISE Homepage*. URL <https://www.jgn.nict.go.jp/rise/english/index.html>
- [83] T. Szyrkowicz, M. Santuari, M. Chamania, D. Siracusa, A. Autenrieth, V. Lopez, J. Cho, W. Kellerer, Automatic Intent-Based Secure Service Creation Through a Multilayer SDN Network Orchestration, *IEEE/OSA Journal of Optical Communications and Networking* 10 (4) (2018) 289–297. doi:[10.1364/JOCN.10.000289](https://doi.org/10.1364/JOCN.10.000289).
- [84] T. Szyrkowicz, M. Santuari, M. Chamania, D. Siracusa, A. Autenrieth, V. Lopez, First Demonstration of an Automatic Multilayer Intent-Based Secure Service Creation by an Open Source SDN Orchestrator, in: *Proc. European Conference on Optical Communication (ECOC)*, Dusseldorf, Germany, 2016,

- pp. 1–3.
- [85] M. Chamania, T. Szyrkowicz, M. Santuari, D. Siracusa, A. Autenrieth, V. Lopez, P. Sköldström, S. Junique, Intent-Based In-Flight Service Encryption in Multi-Layer Transport Networks, in: Optical Fiber Communications Conference and Exhibition (OFC), Los Angeles, CA, USA, 2017, pp. 1–2.
- [86] [LINC - OpenFlow software switch](https://github.com/FlowForwarding/LINC-Switch). URL <https://github.com/FlowForwarding/LINC-Switch>
- [87] A. Kretsis, K. Christodoulopoulos, P. Kokkinos, E. Varvarigos, Planning and operating flexible optical networks: Algorithmic issues and tools, *IEEE Communications Magazine* 52 (1) (2014) 61–69. doi:10.1109/MCOM.2014.6710065.
- [88] L. Liu, W.-R. Peng, R. Casellas, T. Tsuritani, I. Morita, R. Martínez, R. Muñoz, S. B. Yoo, Experimental demonstration of OpenFlow-based dynamic restoration in elastic optical networks on GENI testbed, in: Optical Communication (ECOC), 2014 European Conference on, IEEE, 2014, pp. 1–3. doi:10.1109/ECOC.2014.6964202.
- [89] L. Liu, W.-R. Peng, R. Casellas, T. Tsuritani, I. Morita, R. Martínez, R. Muñoz, M. Suzuki, S. B. Yoo, Dynamic OpenFlow-based lighthpath restoration in elastic optical networks on the GENI testbed, *Journal of Lightwave Technology* 33 (8) (2015) 1531–1539. doi:10.1109/JLT.2014.2388194.
- [90] A. Sadasivarao, S. Syed, P. Pan, C. Liou, A. Lake, C. Guok, I. Monga, Open Transport Switch: A Software Defined Networking Architecture for Transport Networks, in: Proceedings of the second ACM SIGCOMM workshop on Hot topics in software defined networking, ACM, 2013, pp. 115–120. doi:10.1145/2491185.2491192.
- [91] H. Rodrigues, I. Monga, A. Sadasivarao, S. Syed, C. Guok, E. Pouyoul, C. Liou, T. Rosing, Traffic optimization in multi-layered wans using sdn, in: 2014 IEEE 22nd Annual Symposium on High-Performance Interconnects, 2014, pp. 71–78. doi:10.1109/HOTI.2014.23.
- [92] Y. Kanaumi, S.-i. Saito, E. Kawai, S. Ishii, K. Kobayashi, S. Shimojo, RISE: A wide-area hybrid OpenFlow network testbed, *IEICE transactions on communications* 96 (1) (2013) 108–118. doi:10.1587/transcom.E96.B.108.
- [93] H. Harai, Optical packet & circuit integrated network for future networks, *IEICE transactions on communications* 95 (3) (2012) 714–722. doi:10.1587/transcom.E95.B.714.
- [94] T. Miyazawa, H. Furukawa, K. Fujikawa, N. Wada, H. Harai, Development of an autonomous distributed control system for optical packet and circuit integrated networks, *Journal of Optical Communications and Networking* 4 (1) (2012) 25–37. doi:10.1364/JOCN.4.000025.
- [95] H. Furukawa, S. Shinada, T. Miyazawa, H. Harai, W. Kawasaki, T. Saito, K. Matsunaga, T. Toyozumi, N. Wada, A multi-ring optical packet and circuit integrated network with optical buffering, *Optics Express* 20 (27) (2012) 28764–28771. doi:10.1364/OE.20.028764.
- [96] T. Miyazawa, H. Furukawa, N. Wada, H. Harai, Development of a common path control-plane for interoperating hybrid optical packet-and circuit-switched ring networks and WSONs, in: OptoElectronics and Communications Conference and Photonics in Switching, Optical Society of America, 2013, p. TuQ4.2.
- [97] [Successful nationwide flow/path setting by multiple SDN controllers through different optical transport networks mutually connected](http://www.kddi-research.jp/english/newsrelease/2015/042001.html). URL <http://www.kddi-research.jp/english/newsrelease/2015/042001.html>
- [98] H. Harai, N. Wada, Optical Packet and Circuit Integrated Networks, *Journal of the National Institute of Information and Communications Technology* 62 (2) (2015) 15–24.
- [99] R. Doverspike, G. Clapp, P. Douyon, D. M. Freimuth, K. Gullapalli, B. Han, J. Hartley, A. Mahimkar, E. Mavrogiorgis, J. O’Connor, J. Pastor, K. K. Ramakrishnan, M. E. Rauch, M. Stadler, A. V. Lehmen, B. Wilson, S. L. Woodward, Using sdn technology to enable cost-effective bandwidth-on-demand for cloud services [Invited], *IEEE/OSA Journal of Optical Communications and Networking* 7 (2) (2015) A326–A334. doi:10.1364/JOCN.7.00A326.
- [100] A. Sadasivarao, S. Syed, P. Pan, C. Liou, I. Monga, C. Guok, A. Lake, Bursting Data between Data Centers: Case for Transport SDN, in: 2013 IEEE 21st Annual Symposium on High-Performance Interconnects, 2013, pp. 87–90. doi:10.1109/HOTI.2013.20.
- [101] R. Vilalta, A. Mayoral, R. Casellas, R. Martínez, R. Muñoz, Experimental demonstration of distributed multi-tenant cloud/fog and heterogeneous SDN/NFV orchestration for 5G services, in: 2016 European Conference on Networks and Communications (EuCNC), 2016, pp. 52–56. doi:10.1109/EuCNC.2016.7561003.
- [102] R. Martínez, A. Mayoral, R. Vilalta, R. Casellas, R. Muñoz, S. Pachnicke, T. Szyrkowicz, A. Autenrieth, Integrated SDN/NFV orchestration for the dynamic deployment of mobile virtual backhaul networks over a multilayer (packet/optical) aggregation infrastructure, *IEEE/OSA Journal of Optical Communications and Networking* 9 (2) (2017) A135–A142. doi:10.1364/JOCN.9.00A135.
- [103] Y. Yu, J. Zhang, Y. Zhao, Y. Lin, J. Han, H. Zheng, Y. Cui, M. Xiao, H. Li, Y. Peng, Y. Ji, H. Yang, Field demonstration of multi-domain software-defined transport networking with multi-controller collaboration for data center interconnection [Invited], *IEEE/OSA Journal of Optical Communications and Networking* 7 (2) (2015) A301–A308. doi:10.1364/JOCN.7.00A301.
- [104] K. Kanonakis, Y. Yin, A. N. Patel, P. N. Ji, T. Wang, Experimental demonstration of a hybrid intra-DCN architecture with multi-layer SDN control and distributed optical switching, in: 2014 The European Conference on Optical Communication (ECOC), 2014, pp. 1–3. doi:10.1109/ECOC.2014.6964124.
- [105] Y. Zhao, J. Zhang, L. Gao, H. Yang, Unified control system for heterogeneous networks with Software Defined Networking (SDN), in: 2013 8th International Conference on Communications and Networking in China (CHINACOM), 2013, pp. 781–784. doi:10.1109/ChinaCom.2013.6694700.
- [106] Y. Zhao, J. Zhang, H. Yang, X. Yu, Data center optical networks (DCON) with OpenFlow based Software Defined Networking (SDN), in: 2013 8th International Conference on Communications and Networking in China (CHINACOM), 2013, pp. 771–775. doi:10.1109/ChinaCom.2013.6694698.
- [107] L. Velasco, L. Gifre, J.-L. Izquierdo-Zaragoza, Toward Multi-layer Disaggregated Node Telemetry and Local Decision Making, in: Optical Fiber Communication Conference, Optical Society of America, 2018, pp. 1–3. doi:10.1364/OFC.2018.Th2A.28.
- [108] L. Gifre, J. L. Izquierdo-Zaragoza, M. Ruiz, L. Velasco, Autonomous disaggregated multilayer networking, *IEEE/OSA Journal of Optical Communications and Networking* 10 (5) (2018) 482–492. doi:10.1364/JOCN.10.000482.
- [109] S. Yan, A. Aguado, Y. Ou, R. Nejabati, D. Simeonidou, Demonstration of an SDN based monitoring framework for converged packet and optical networks analytics, in: 2016 Optical Fiber Communications Conference and Exhibition (OFC), 2016, pp. 1–3. doi:10.1364/OFC.2016.W3F.4.
- [110] S. Yan, A. Aguado, Y. Ou, R. Wang, R. Nejabati, D. Simeonidou, Multilayer Network Analytics with SDN-based Monitoring Framework, *IEEE/OSA Journal of Optical Communications and Networking* 9 (2) (2017) A271–A279. doi:10.1364/JOCN.9.00A271.
- [111] B. Jäger, C. Röpke, I. Adam, T. Holz, Multi-layer access control for sdn-based telco clouds, in: *Secure IT Systems*, Springer International Publishing, 2015, pp. 197–204.
- [112] T. Szyrkowicz, M. Santuari, M. Chamania, D. Siracusa, A. Autenrieth, V. López, J. Cho, W. Kellerer, Automatic intent-based secure service creation through a multilayer SDN network orchestration, *CoRR abs/1803.03106* (2018).
- [113] L. Zhao, J. Hua, X. Ge, S. Zhong, Traffic engineering in hierarchical SDN control plane, in: 2015 IEEE 23rd International Symposium on Quality of Service (IWQoS), 2015, pp. 189–194. doi:10.1109/IWQoS.2015.7404732.

- [114] S. Jain, A. Kumar, S. Mandal, J. Ong, L. Poutievski, A. Singh, S. Venkata, J. Wanderer, J. Zhou, M. Zhu, J. Zolla, U. Hölzle, S. Stuart, A. Vahdat, B4: Experience with a globally-deployed Software Defined WAN, in: Proceedings of the ACM SIGCOMM 2013 Conference on SIGCOMM, SIGCOMM '13, ACM, New York, NY, USA, 2013, pp. 3–14. [doi:10.1145/2486001.2486019](https://doi.org/10.1145/2486001.2486019).
- [115] N. Sambo, F. Cugini, A. Sgambelluri, P. Castoldi, Monitoring Plane Architecture and OAM Handler, *Journal of Lightwave Technology* 34 (8) (2016) 1939–1945.
- [116] S. Tse, G. Choudhury, Real-time traffic management in at&t's sdn-enabled core ip/optical network, *Optical Fiber Communication Conference* (2018) Tu3H.2 [doi:10.1364/OFC.2018.Tu3H.2](https://doi.org/10.1364/OFC.2018.Tu3H.2).